

**Marlow**<sup>®</sup>

**NEW FOR 2019!**  
PRODUCT DEVELOPMENTS  
INC NEW D2 RACING &  
EXCEL RACING COVERS



**THE DEFINITIVE ROPE GUIDE**

**QUANTUM**

**ISSUE 6**





Bella Mente





# Marlow®

Every business can be defined by where they've come from, how they conduct themselves and where they plan to be. So it is at Marlow, where these thoughts define everything we do.

We are extremely proud of our heritage – not only as a brand recognised around the world for quality, performance and innovation, but as a business with ties to the local community going back over 200 years.

However, with our history and reputation comes responsibility and we are committed to maintaining the quality and service that our customers have come to expect.

As to the future, we strive for innovation and growth, constantly looking at ways to improve and develop – not only our range of world beating products, but our service and availability to every sailor around the globe.



# CONTENTS



COMPANY PROFILE 5  
MARLOW SECTORS 5

GRAND PRIX SERIES 6  
GRAND PRIX PROJECTS 7  
CORE TECHNICAL REFERENCE 8  
GRAND PRIX CORES 11  
GRAND PRIX COVER TECHNOLOGY 12  
GRAND PRIX COVERS 13  
ACCESSORIES & CUSTOMISATIONS 14

SUPER YACHT SERIES 16  
PROJECTS & TECHNOLOGY 17  
RUNNING RIGGING 19  
MOORING 21  
OCEANUS 21

CLASSIC SERIES 22  
CLASSIC PROJECTS 23  
HIGH TECH CLASSICS 24  
TRADITIONAL CLASSICS 25

CRUISER & RACER SERIES 26  
RUNNING RIGGING DEFINITIONS 27  
CRUISER RACER PRODUCTS 29

EXCEL DINGHY SERIES 32  
SPONSORED SAILORS / TEAMS 33  
RUNNING RIGGING DEFINITIONS 34  
EXCEL DINGHY PRODUCTS 35

EXTREME SPORTS 41

MOORING 42

ACCESSORIES 46  
SPLICING TOOLS 47  
WEBBING & CORDS 48  
RACKING 49  
MAST CLIMBING 50

USEFUL INFORMATION 52  
LINE SELECTION GUIDE 53  
CARE AND STORAGE 54



# COMPANY PROFILE

## QUALITY, INNOVATION, TECHNICAL EXCELLENCE

In 1807 Thomas Burfield opened his rope factory in Hailsham, East Sussex and, over 200 years later, Marlow Ropes continue to manufacture ropes on the same site.

In the mid 1950's Burfield and Son's was incorporated into the expanding Hawkins and Tipson Rope Group, founded by George Hawkins and Alfred Tipson in 1881. At this time, the factory in Hailsham was one of the first in the world to be manufacturing synthetic fibre ropes. These ropes were specifically made for the yachting industry under the new "Marlow" brand.

These new nylon and polyester ropes were ideal for the demands of the re-emerging yachting industry, which was recovering after World War II. The success of the "Marlow" brand led to the founding of Marlow Ropes Ltd in 1961, as part of the Hawkins and Tipson Group, with the express purpose of manufacturing synthetic fibre ropes for the yachting market.

Very soon Marlow Ropes became internationally known as leaders in the field and over the course of the following decades, moved from

strength to strength, further asserting its dominance in the yachting industry with innovation and marketing.

Today, over 200 years after Thomas Burfield first set up his rope factory, Marlow Ropes continue to manufacture innovative and quality British products in Hailsham, East Sussex. Our reputation for quality and technical innovation continues in the 21st Century and the company continues to forge a path of progress and growth in the markets in which we operate.

At Marlow we recognise that being a market leader in the global leisure marine industry is not just about great products that you can trust – customer service is key.

"Since it's the customer that pays our salary, our responsibility is to make the product they want, when they want it, and deliver quality that satisfies them", this is a quote from a retired Toyota factory worker and it is the maxim by which everybody at Marlow Ropes carries out their working day.

From stock levels, which gives us enviable On Time In Full delivery statistics for our standard range of products, to capacity planning that allows us to turn around complex made to order Grand Prix Series ropes in a matter of days or even hours. When this commitment to delivery is married with our stringent quality control systems and the diligent dedication of our employees, it means that we are confident that you get the product you want, when you want it, with quality that satisfies you.

We are proud to fly the flag for British manufacturing. Our factory in Hailsham is still on the same site that ropes were first made in the town in 1807, and we remain a key local employer with some of our staff being 3rd or 4th generation ropemakers. However, we always have an eye to the future and over the past few years we have expanded our factory and grown our work force to meet increasing demand.

Everything is driven by our passion and commitment. With Marlow you get a global guarantee of quality, service, commitment and a brand you can trust.

## SECTORS

LEISURE MARINE

DEFENCE & SPECIAL FORCES

VEHICLE RECOVERY

ARBORICULTURE

ROPE ACCESS

FIRE & RESCUE

CABLING & TELECOMS

FILM & EVENT RIGGING

MARINE & OFFSHORE

GENERAL INDUSTRIAL

UTILITY

**COVER IMAGE :** ROLEX TP52 WORLD CHAMPIONSHIP CASCAIS 2018, © MARTINEZ STUDIO

## IMAGE CREDITS:

Andrea Francolini  
Clipper Ventures Plc  
SD Boatworks  
MartinezStudio.es

Martina Orsini  
Marlow Ropes  
Christopher Scholey  
Igo Aznar

Paul Wyeth / RYA  
Richard Langdon  
Neil Pryde  
Onne Van Der Wal

Guido Contini/ Panerai  
Carlo Borlenghi./Elisabet  
Cynthia Sinclair Photo  
PW Pictures







Spirit Yachts  
Amory Moss/ BellaMente

'Marlow' and the 'Black Marker' are registered trade marks of MARLOW ROPES LTD.

Marlow Ropes Ltd endeavor to ensure that all products are manufactured to the highest standards, these guidelines are for information only and do not create any warranties, expressed or implied, of merchantability or fitness for a particular purpose. Marlow Ropes Ltd shall not be liable for any loss or damage whatsoever relating from the use of these guidelines. Marlow Ropes Ltd has a policy of continual improvement which may result in

All trademarks are recognised: Vectran®, Technora®, Dyneema® is a registered Trademark of Royal DSM N.V.

## KEY

 HIGH STRENGTH	 LIGHT WEIGHT
 LOW STRETCH	 HIGH ABRASION RESISTANCE
 LOW WATER ABSORPTION	 HIGH FLEX/SOFT HANDLING



# GRAND PRIX SERIES

***In the Maxi72 class, development is key to success and you have to constantly push forward in all areas. Running rigging is often over looked and the possible gains are underestimated. Working with Marlow from the beginning of the project, we can trust the quality of the product and rely on their great technical expertise and commitment to make even the shortest time frame work. It's great to have a strong partner in Marlow to tackle your challenges.***

MICHAEL MÜLLER: MÜLLER SAILING CONSULTING SERVICE

Marlow's Grand Prix Series has revolutionised the way high performance running rigging is specified and ordered. Imitated by many, but matched by none, the Grand Prix Series was developed and is continuously improved through our long experience with high performance race teams and feedback from our global network of specialist Grand Prix Riggers.

The Grand Prix Series uses the highest performance materials such as Dyneema® SK99, Zylon®, Technora®, Kevlar® Teflon® and Zyex®. These materials offer attributes to covers and cores such as higher strength, improved abrasion resistance, better thermal properties, higher (or lower) friction and improved winch handling properties.

Finally, a wide variety of customisations including core inserts, tapered ropes and hoist markers are available along with rigging extras such as chafe cover and ArmourCoat.

The reason Marlow's Grand Prix Series ropes work so well and are so respected is that we listen to the feedback and needs of our Grand Prix Riggers and their customers – the race boat captains and crews. When combined with our attention to detail and passion for excellence, Marlow's Grand Prix Series ropes deliver reliable, race winning performance.



# GRAND PRIX PROJECTS

SOME OF THE BOATS SUPPLIED WITH MARLOW GRAND PRIX SERIES THROUGH OUR GRAND PRIX RIGGING PARTNERS.



## MAXI

WILD OATS 100  
RAMBLER 88  
CARIBBEAN 600

9 TIME SYDNEY TO HOBART WINNER  
LINE HONOURS AND RACE RECORD HOLDER

LINE HONOURS NEWPORT TO BERMUDA RACE  
2ND LES VOILES DE ST-BARTH  
LINE HONOURS NOAKES SYDNEY TO GOLD COAST RACE

BLACK JACK 100

COMANCHE 100

W.S.S.R.C TRANSATLANTIC WEST TO EAST. AMBROSE LIGHT - LIZARD POINT MONOHULL  
2 TIMES SYDNEY HOBART WINNER AND RACE

RECORD HOLDER

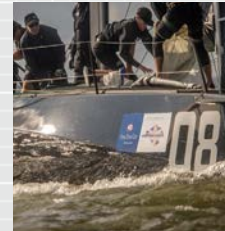

## FAST 40+ 2018 CIRCUIT

RAN	1ST
GIRLS ON FILM	2ND
REBELLION	3RD
JUBILEE	5TH
PACE	6TH
TOKOLOSHE	7TH
ELVIS	8TH
ZEPHYR	9TH
TSCHUSS	12TH



## MINI MAXI

MOMO

2017 & 2018 WORLD CHAMPIONS  
1ST ROLEX GIRAGLIA RACE  
1ST COPA DEL REY

JETHOU  
SORCHA  
CAOL ILA

3RD ROLEX CAPRI SAILING WEEK  
3RD LES VOILES DE ST-BARTH  
2ND ROLEX CAPRI SAILING WEEK  
3RD ROLEX GIRAGLIA RACE  
4TH ROLEX CAPRI SAILING WEEK  
LAUNCHED LATE 2018

LUCKY  
BELLA MENTE



## PAC 52 CLASS

INVISIBLE HAND	1ST
INTERLODGE	2ND
RIO	3RD PAC52 CUP CHAMPIONS
BADPAK	4TH



## TP52 (SUPER SERIES ATLANTIC CUP) 2018

QUANTUM RACING 1ST TP52 SUPER SERIES CHAMPIONS AND WORLD CHAMPIONS

PLATOON	2ND
AZZURRA	3RD
ALEGRE	6TH
PROVEZZA	8TH
ONDA	9TH
GLADIATOR	10TH



## WALLY

LYRA	1ST MAXI YACHT ROLEX CUP
	1ST LES VOILES DE SAINT TROPEZ
MAGIC CARPET 3	1ST WALLY CLASS TROPHY
	2ND LES VOILES DE SAINT TROPEZ
	3RD MAXI YACHT ROLEX CUP
GALATEIA	2ND GIRAGLIA COMBINED INSHORE AND OFFSHORE

## OTHER

IL MOSTRO V70  
WARRIOR V70

LINE HONOURS AND RACE RECORD HOLDER BYC MACKINAC RACE  
3RD CARIBBEAN 600  
LINE HONOURS ANTIGUA TO BERMUDA RACE  
LINE HONOURS AND RACE RECORD HOLDER ROUND ANTIGUA RACE

ICHI BAN TP52

1ST FLINDERS ISLET RACE  
OVERALL WINNER OF SYDNEY HOBART ON CORRECTED TIME  
OVERALL WINNER OF ANTIGUA TO BERMUDA RACE ON CORRECTED TIME  
BERMUDA TO HAMBURG RACE

VARUNA  
1ST

\*WSSRC = WORLD SAILING SPEED RECORD COUNCIL





# CORE TECHNICAL REFERENCE

Marlow's Grand Prix Series offers a range of core options using Dyneema®, Vectran® and Zylon® (PBO). Each material has its own particular strengths and weaknesses.

**Dyneema®** offers by far the best strength to weight ratio of any material used in rope manufacture and is the material of choice for high performance cores. At Marlow we offer a range of Dyneema® cores to suit strength and handling preferences as well as budget.

Dyneema® is an Ultra High Molecular Weight Polyethylene (UHMWPE) and is available in a number of different grades. All grades of Dyneema® have excellent fatigue resistance (cyclic bending), UV resistance and abrasion resistance, but have poor heat resistance due to a relatively low melting point.

- **SK78** is now the standard material offering very high strength but significantly improved creep characteristics over its predecessor SK75 or equivalents.
- **SK99** is the very latest Dyneema® material. It offers exceptional strength (some 20% higher than SK78) and is unmatched in terms of strength to weight ratio.
- **SK38** is the dyneema grade offering the highest elongation, this fibre has lower tenacity than SK75/8 and is ideally suited to upgrade applications from polyester ropes where it offers a mid point between Polyester and the higher performing Dyneema grades.

- **DM20** has slightly lower tenacity than SK78, but has one major advantage in that it exhibits virtually zero creep, which can often have a negative affect on a rope's performance and strength, at high loads for an extended period.

**Vectran®** (LCP) has the best creep performance of any synthetic fibre and can offer improved resistance to heat compared to the UHMPE family.

**Zylon®** (PBO) offers unrivaled strength/diameter performance coupled with exceptional resistance to heat and ultra low elongation. PBO is very susceptible to UV degradation.

## STRENGTH

The graphs below illustrate the comparative strengths of different core materials, based upon a 9mm core used in a 12mm rope.

Fig. 1 shows the relative strengths of 9mm ropes made with different materials. However, whilst displaying break strengths comparable or better than Dyneema®, the additional weight of Vectran® and Zylon® (PBO) ropes (Fig.2) cannot compare to the strength to weight ratio of Dyneema® (Fig.3), illustrating why Dyneema® is preferred by the majority of racers.

## PRE-STRETCHING AND MARLOW MAX TECHNOLOGY

Every Marlow Dyneema® core is pre-stretched to reduce "bedding in" elongation, limit the amount of elastic elongation and improve rope strength. We have been pre-stretching Dyneema® cores for over 25 years and that experience means we know exactly how to improve the rope's performance without compromising flexibility or damaging the fibre.

Marlow's MAX Technology uses a precisely controlled process to take Dyneema® to the limits of heat and load during Pre-Stretching. Introduced to offer the ultimate in strength realization from the fibre and to minimize elastic and "bedding-in" elongation, MAX ropes are stiffer than standard pre-stretched cores.

CORE STRENGTH COMPARISON  
9mm (CORE FOR 12mm ROPE CORE STRENGTHS)

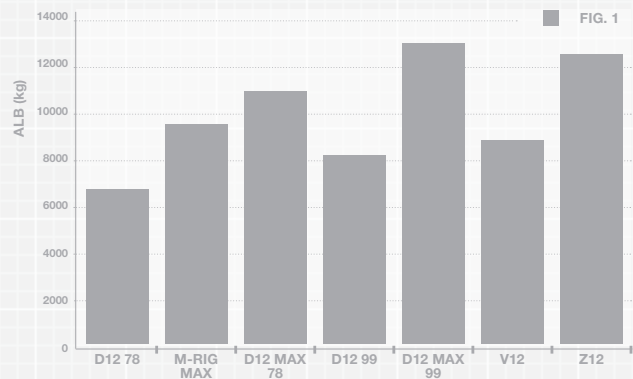

CORE WEIGHTS (mm)

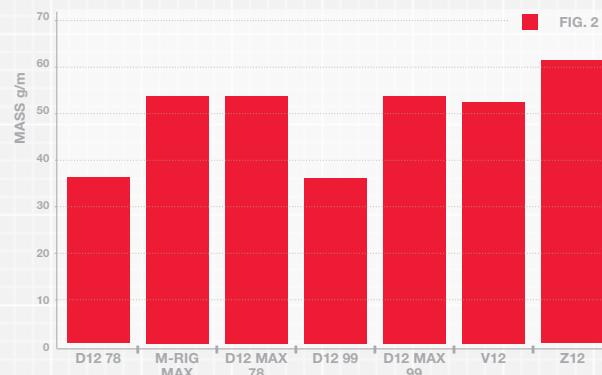

TENACITY (kg/g)

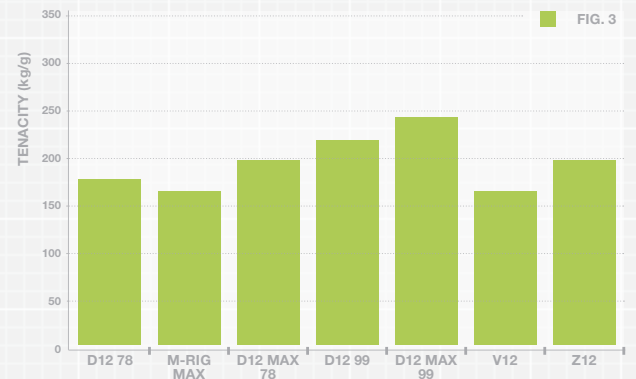



### MATERIAL ELONGATION COMPARISON GRAPHS

These graphs show the relative elongation of Dyneema® SK78 and SK99 to Vectran® and Zylon® (PBO).

When elongation is measured as a % of break load (fig. 4), it is shown that whilst Zylon® offers the lowest elongation followed by Dyneema® in D12 Max and then D12, there is no differential between SK78 and SK99. However, when elongation is measured at a given load (for example 4,000kg), which is more relevant to specifying rope for on board applications (fig.5), it can be seen that the advantages of SK99 over SK78 in terms of elongation are clear. This is because the rope is working at a lower percentage of the its break load.

However, as Dyneema® exhibits creep, it is important to understand how this affects Dyneema's elongation characteristics.

The extension over time graph (Fig. 6) shows how Dyneema® ropes behave over a period of time.

- Initial loading will result in elastic extension. This is immediate upon loading and is immediately recoverable upon release of the load (elastic contraction)
- After the elastic extension of the initial loading, the rope will experience what is known as viscoelastic extension. This is further extension over time and is fairly limited. Unlike elastic stretch that is immediately recoverable, viscoelastic stretch will recover slowly over time once the load is released.
- Finally there is creep, which is permanent, non-recoverable and time dependent. Creep occurs at the yarn molecular level when the rope is under constant load.
- Once the load is released and elastic and viscoelastic extension recovered, the rope will ultimately have experienced an element of permanent extension. This is a factor of both creep and "bedding in" which is when individual fibre components in the rope and / or splice settle into their preferred position when under load.

Vectran® and Zylon® (PBO) exhibit virtually zero creep and Zylon also has lower elastic elongation than Dyneema®.

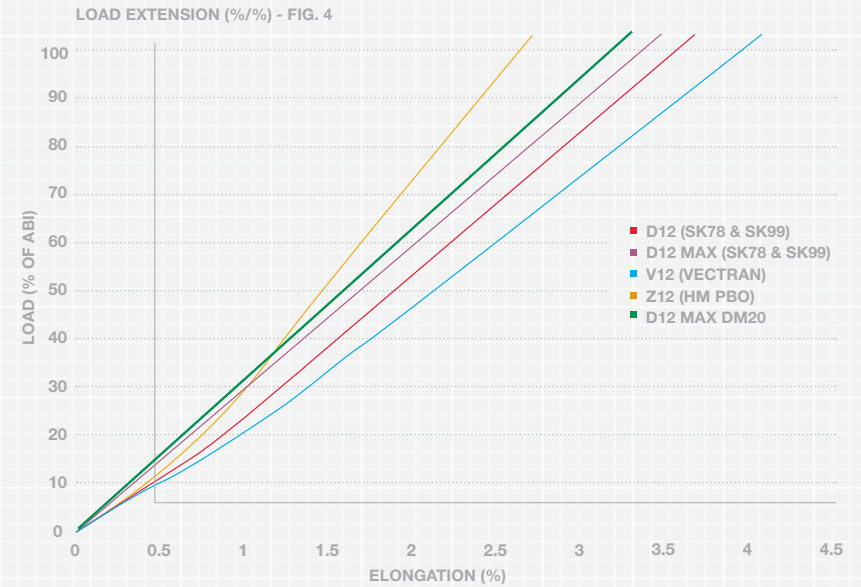

EXTENSION OVER TIME GRAPH - FIG. 6

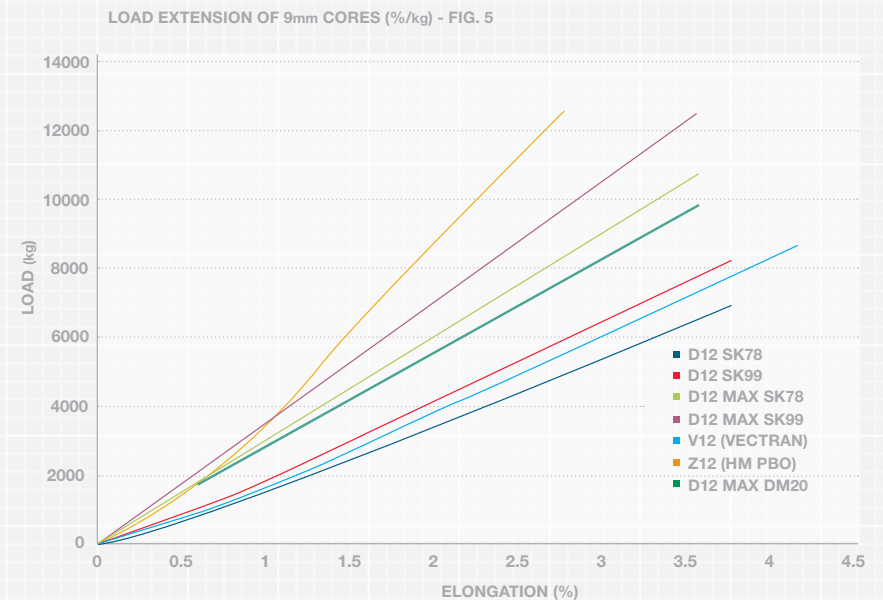
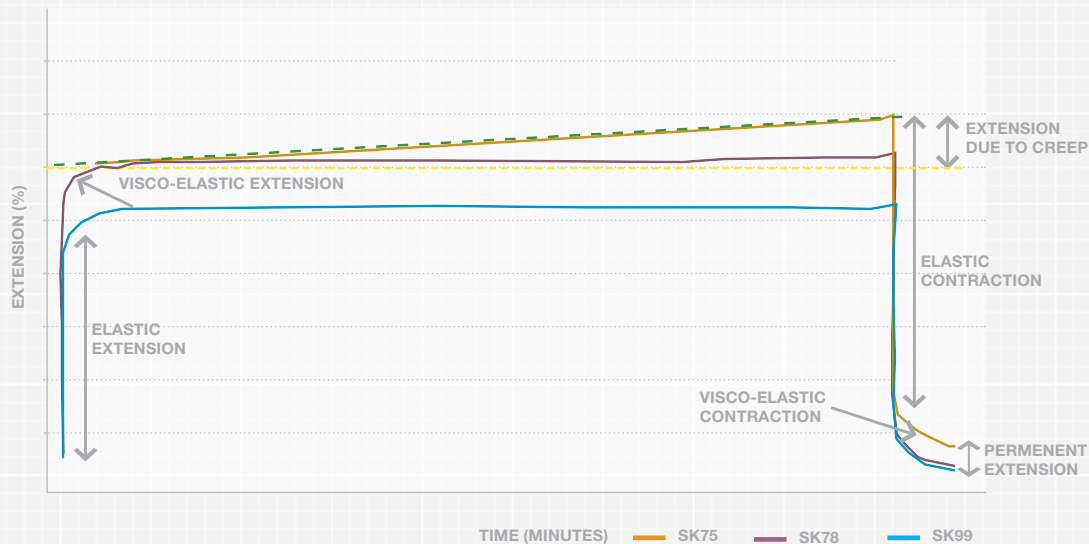







# CORES

(Grand Prix Cores specified uncovered or covered with an MGP Cover detailed on page 13)

## D12 MAX



**Construction:** 12 strand

**Material:** Dyneema® Available in SK99 and SK78

**Extras:** Marlow's Super Pre-Stretch process, ArmourCoat

**Features:** Ultimate high strength, light weight, low elongation ropes

DIAMETER (mm)	2.5	3	4	5	6	7	8	9	10	11	12	13	15	17
SK99 BREAK LOAD (kg)	1200	1790	2950	3810	5440	8940	11200	12500	14600	17500	20900	24500	30700	38100
SK78 BREAK LOAD (kg)	1010	1510	2480	3200	4570	7510	9390	10800	12600	15100	18000	21100	26400	32900
WEIGHT kg/100m	0.45	0.68	1.11	1.56	2.23	3.56	4.45	5.40	6.30	7.55	9.00	10.7	13.4	18.4

For high-load, diameter or safety critical applications, D12 Max is the only choice, either covered or uncovered. Stiffer than standard D12, D12 Max is taken to the limit of its physical properties during the manufacture process resulting in a rope unrivalled in strength and low elongation. Max 99 offers approximately 20% higher break load over Max 78.

## D12



**Construction:** 12 strand

**Material:** Dyneema® Available in SK99 and SK78

**Extras:** Pre-Stretched, ArmourCoat

**Features:** Light weight, low stretch & high strength. D12 78 & 99 demonstrate lower creep than other types of UHMWPE fibres.

DIAMETER (mm)	2.5	3	3.5	4	5	6	6.5	7	8	9	10	11	12	13	15	16	18	20
SK99 BREAK LOAD (kg)	677	1180	1710	2450	2800	4150	5280	6380	7530	8260	11000	13800	15200	18400	21400	24500	29200	38900
SK78 BREAK LOAD (kg)	569	995	1430	2060	2360	3490	4440	5360	6330	6940	9270	11600	12800	15900	18400	21100	25200	33500
WEIGHT kg/100m	0.37	0.53	0.74	0.98	1.28	1.77	2.20	2.80	3.30	3.76	4.83	5.82	6.5	8.00	9.80	11.8	14.3	18.0

The workhorse of any racing yacht, uncovered D12 can be used for strops, lashing, purchase systems, backstays and some halyards. With a cover, D12 is ideal for sheets halyards, runners, control lines etc. D12 99 offers approximately 20% higher break load over D12 78.

## M-RIG MAX



**Construction:** 12 strand

**Material:** Dyneema® DM20

**Extras:** Marlow's Super Pre-Stretch process, ArmourCoat

**Features:** Ultimate Low Creep, light weight rope.

DIAMETER (mm)	2.5	3	4	5	6	7	8	9	10	11	12	13	15	17
BREAK LOAD (kg)	902	1350	2220	2870	4110	6740	8430	9690	11300	13600	16200	19000	23700	29500
WEIGHT kg/100m	0.45	0.68	1.11	1.56	2.23	3.56	4.45	5.40	6.30	7.55	9.00	10.7	13.4	18.4

M-Rig Max's top benefit is minimal creep ideal for standing rigging and steering lines. Add an MGP cover or light weight chafe cover for high wear applications such as life lines. See page 31 for more details on M-Rig Max.

## Z12

ZYLON



**Construction:** 12 strand

**Material:** Zylon® (PBO)

**Extras:** ArmourCoat

**Features:** Very high strength, very low stretch and zero creep

DIAMETER (mm)	3	3.5	4	5	6	7	9	10	11	13	15	16	18
BREAK LOAD (kg)	1470	2350	2940	3820	5290	7930	12600	15400	18500	24900	31400	37700	44400
WEIGHT kg/100m	0.72	1.15	1.44	1.87	2.59	3.89	6.16	7.56	9.07	12.2	15.4	18.5	21.8

Where very high strengths are essential, UV exposure can be managed and bending cycles minimised – Stays, trip lines etc.

## V12

Vectran®



**Construction:** 12 strand

**Material:** Vectran®

**Extras:** ArmourCoat

**Features:** High strength, very low stretch and zero creep

DIAMETER (mm)	2.5	3	4	5	6	7	9	10	11	13	15	16	18
BREAK LOAD (kg)	627	993	1680	2410	3350	5750	8680	11000	12000	14700	18400	22700	25100
WEIGHT kg/100m	0.45	0.67	1.34	1.79	2.24	3.36	5.38	6.72	8.96	10.8	14.1	17.0	18.8

Where zero creep is essential and UV exposure can be managed in non weight critical applications - and halyards, steering systems, strops.



# COVER TECHNOLOGY

The interaction between core, cover and deck gear are fundamental elements of a rope's performance. The Grand Prix Series blends technical materials to impart application specific properties to the cover.

The properties of different materials will have a varying impact on the interaction between rope & deck gear, by blending different materials in different ratios we are able to best utilize these material properties to produce the perfect rope performance.

The data on page 13 details our standard blend covers & their relative performance in terms of abrasion resistance, load holding capability & winch easing.

Grand Prix Series covers can be specifically and uniquely customised to particular requirements using different material blend ratios and blends of 3 or even 4 materials.

## COVER CONSTRUCTIONS

All Grand Prix Series ropes are fully customisable. Different cover constructions have different properties and performance characteristics.

24 plait – thicker cover, offers excellent grip, good durability and flexibility. Easy to splice with all core configurations and is the standard cover construction for most running rigging applications

32 plait – thinner cover, smooth running through blocks and sheaves. Often used when a larger core is needed for strength without increasing diameter, but is more technical and time consuming to splice than 24 plait.

48 plait – very thin cover, very smooth and easily expandable. Normally made with Dyneema® offering outstanding resistance to abrasion so used for chafe gear and covers for loops and lashings. Also used for standing rigging overbraids.

FIBRE	STRENGTH		MODULUS		ELONGATION	SPECIFIC GRAVITY	MELTING POINT °C	CRITICAL TEMPERATURE °C	CREEP PERFORMANCE	CHEMICAL RESISTANCE	UV RESISTANCE
	G/DEN	GPA	G/DEN	GPA							
DYNEEMA® SK99 (UHMWPE)	48	4.1	1800	132	3.6	0.975	144-152	80	GOOD	EXCELLENT	VERY GOOD
DYNEEMA® SK90 (UHMWPE)	44.7	3.8	1625	140	3.5	0.975	144-152	80	GOOD	EXCELLENT	VERY GOOD
DYNEEMA® SK78 (UHMWPE)	40	3.4	1267	110	3.5	0.975	144-152	80	GOOD	EXCELLENT	VERY GOOD
DYNEEMA® DM20 (UHMWPE)	35	3	1042	90	3.6	0.975	144-152	80	VERY GOOD	EXCELLENT	VERY GOOD
ZYLON® TYPE HM (PBO)	42	5.8	1948	270	2.5	1.56	650	N/A	VERY GOOD	FAIR	POOR
ZYLON® TYPE AS (PBO)	42	5.8	1302	180	3.5	1.54	650	N/A	VERY GOOD	FAIR	POOR
ZYEX® (PEEK)	6.5	-	-	-	30	1.3	334	250	N/A	VERY GOOD	VERY GOOD
TEFLON® (PTFE)	2	0.36	13	-	8.5	2.1	310	288	N/A	EXCELLENT	EXCELLENT
TECHNORA® (PARA-ARAMID)	27	3.4	590	73	4.5	1.39	500	N/A	VERY GOOD	FAIR	FAIR
TWARON® (PARA-ARAMID PPTA)	23	2.9	600	78	3.55	1.44	450	N/A	VERY GOOD	FAIR	FAIR
VECTRAN® (LCP)	25.9	3.2	600	75	3.8	1.41	350	N/A	EXCELLENT	GOOD	GOOD
POLYESTER	9.5	1.13	125	15	12.5	1.38	260	N/A	GOOD	AFFECTED BY ALKALIS	VERY GOOD
POLYAMIDE (NYLON 6)	8.7	0.96	80	8	24	1.14	220	N/A	GOOD	AFFECTED BY ALKALIS	GOOD

## STANDARD MARLOW CORE TO COVER RATIOS

CORE COVER MATRIX

COVERED ROPE DIAMETER (mm)	6	7	8	9	10	11	12	14	16
CORE DIAMETER (mm)	4	5	6	6.5	7	8	9	10	12
COVERED ROPE DIAMETER (mm)	18	20	22	24	26	28			
CORE DIAMETER (mm)	13	15	16	18	19	20			

## ABRASION RESISTANCE

TEST PERFORMED AROUND 2" HEAVILY GNARLED BAR

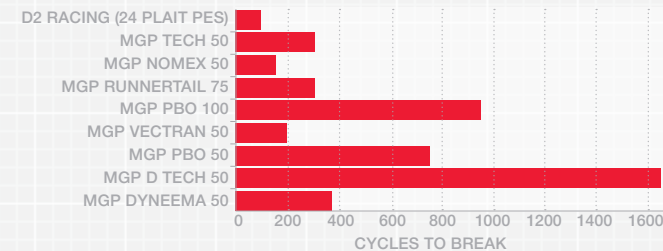

## LOAD HELD IN CLUTCH/JAMMER

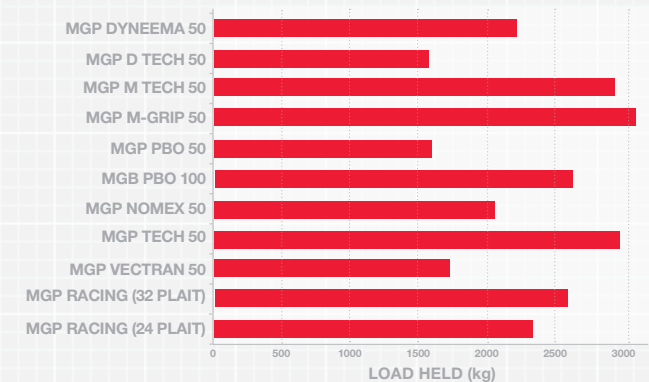



# COVERS

## MGP RACING 100



24 Plait, 100% Polyester cover offers good all-round performance. Cost effective option for general purpose lines subjected to relatively low heat and abrasion.

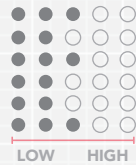

Clutch & Jammer Performance  
Winch Drum Performance  
Abrasion Resistance  
Thermal Resistance  
Water Absorption  
Weight

## MGP PBO 100



24 Plait, 100% PBO has outstanding heat & abrasion resistance properties for high load, high temperature applications. Use for runners and high load sheets where winch easing is of particular importance.

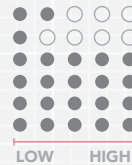

Clutch & Jammer Performance  
Winch Drum Performance  
Abrasion Resistance  
Thermal Resistance  
Water Absorption  
Weight

## ZYLON

## MGP PBO 50



24 Plait PBO & Polyester blend offers higher heat & abrasion resistance than MGP Tech 50, but at the expense of grip. More turns required on the winch, but will ease smoothly.

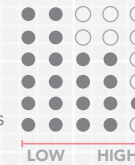

Clutch & Jammer Performance  
Winch Drum Performance  
Abrasion Resistance  
Thermal Resistance  
Water Absorption  
Weight

## ZYLON

## MGP TECH 50



24 Plait Technora® & Polyester blend is the workhorse of Grand Prix racing. Great heat & abrasion resistance & a perfect balance between grip & easing on winches. Perfect for Jib & Spin sheets as well as Halyards while racing round the cans, where fewer turns on the winch are needed for transition efficiency.

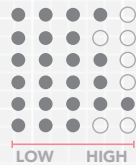

Clutch & Jammer Performance  
Winch Drum Performance  
Abrasion Resistance  
Thermal Resistance  
Water Absorption  
Weight

## MGP VECTRAN® 50



24 Plait Vectran® Polyester blend is favoured by single handed sailors. Easier to ease than MGP Tech 50 and will slip sooner when over-loaded. Good for general use, sheets etc.

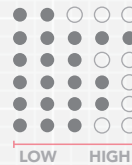

Clutch & Jammer Performance  
Winch Drum Performance  
Abrasion Resistance  
Thermal Resistance  
Water Absorption  
Weight

## MGP DYNEEMA® 50



24 Plait Dyneema® & Polyester blend. MGP Dyneema® 50 is lighter and has less water uptake than other cover combinations making it ideal for lightweight sheets, light halyards for locks and halyard tails.

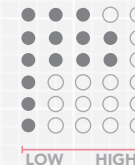

Clutch & Jammer Performance  
Winch Drum Performance  
Abrasion Resistance  
Thermal Resistance  
Water Absorption  
Weight

NOW AVAILABLE IN BLACK DYNEEMA®

## MGP P TECH 50



24 Plait PBO & Technora blend offers excellent heat resistance in high load, high temperature applications such as gennaker sheets, runners & high load mainsheets. Better grip than 100% PBO, but the blend offers the winch easing properties of PBO.

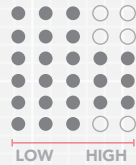

Clutch & Jammer Performance  
Winch Drum Performance  
Abrasion Resistance  
Thermal Resistance  
Water Absorption  
Weight

## MGP M-GRIP 50

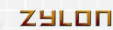

24 Plait PBO & Zyex® blend. Independent tests prove that M-Grip out performs any other rope in clutch holding & winch grip performance. Added to this outstanding thermal & abrasion resistance properties, this truly is the ultimate MGP cover.



Clutch & Jammer Performance  
Winch Drum Performance  
Abrasion Resistance  
Thermal Resistance  
Water Absorption  
Weight

## MGP D TECH 50



24 Plait or 32 Plait Dyneema® and Technora® blend is also the standard cover for our Superyacht Series Oceanus. Dyneema® offers outstanding abrasion resistance whilst Technora® offsets the poor heat tolerance and low friction of the Dyneema®. Great for captive winches, pinch rollers, small pin diameters and applications with extreme abrasion.



Clutch & Jammer Performance  
Winch Drum Performance  
Abrasion Resistance  
Thermal Resistance  
Water Absorption  
Weight

ALSO AVAILABLE IN BLACK DYNEEMA®



# OTHER ROPES & ACCESSORIES

## MGP FURLER 50



**Diameters:** 7-12mm  
**Cover:** 16 or 24 Plait | Vectran / Polyester Snake skin  
**Core Material:** Polypropylene or Dyneema® D12  
**Colours:** Natural / Any  
**Application:** Continuous furling systems

Snake skin pattern allows easy end-to-end splicing with no diameter increase. Vectran or Technora cover ensures heat and abrasion resistance. Has a sacrificial Polypropylene core as standard, but can be up graded to a D12 core for higher load furling systems.

●	●	○	○	○	Clutch & Jammer Performance
●	●	●	●	●	Winch Drum Performance
●	●	○	○	○	Abrasion Resistance
●	●	●	●	○	Thermal Resistance
●	●	●	●	○	Water Absorption
●	●	○	○	○	Weight
LOW		HIGH			

## LIFELINE REFLECTIVE



**Diameters:** 4mm, 6mm & 7mm **ALSO AVAILABLE IN BLACK DYNEEMA®**  
**Cover:** 16 or 24 plait Dyneema® or Technora®  
**Core Material:** D12 Max | Dyneema® SK78 / SK99 | M Rig  
**Colours:** Black and white  
**Application:** Lifelines

High strength, very low elongation and creep, manufactured to exact diameter specification for use as abrasion resistant, lightweight fibre lifelines including a reflective marker which is easily visible with a head torch.

## LIFELINE



**ALSO AVAILABLE IN BLACK DYNEEMA®**

**Diameters:** 4mm, 6mm & 7mm  
**Cover:** 16 or 24 plait Dyneema® or Technora®  
**Core:** D12 Max | Dyneema® SK78 / SK99 | M Rig  
**Colours:** Black and white  
**Application:** Lifelines

High strength, very low elongation and creep, manufactured to exact diameter specification for use as abrasion resistant, lightweight fibre lifelines.

## CHAFE SLEEVE (DYNEEMA®)



**ALSO AVAILABLE IN BLACK DYNEEMA®**

**Diameters:** 8mm – 24mm  
**Cover:** 32 plait | 48 plait | Dyneema®  
**Colours:** White or PU coated Black  
**Application:** High wear rope sections, halyard tips.

48 Plait construction allows this cover to open up easily, making it perfect additional rope cover, tip or loop cover. Excellent for areas of high abrasion where very low friction is not an issue.

## CHAFE SLEEVE PRO

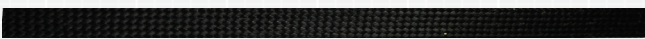

**ALSO AVAILABLE IN BLACK DYNEEMA®**

**Diameters:** 8mm - 24mm  
**Cover:** 32 Plait | 48 plait | Dyneema®  
**Coating:** None  
**Colours:** Black and white  
**Application:** Thinner Dyneema® therefore ideal for lock strops.

Slightly thinner and slightly lighter and has a wider range of diameters. Ideal for lock strops. Excellent for areas of high abrasion where very low friction is not an issue.

## BLENDED CHAFE SLEEVE



**Diameters:** 8mm - 24mm  
**Cover:** 32 plait | 48 plait | Dyneema®/ Technora® blend  
**Coating:** None  
**Colours:** Dyneema® - black | white, Technora® - black | natural  
**Application:** Halyard tips, high friction areas.

The blended chafe sleeve is an alternative to the standard sleeves but offers higher abrasion resistance.

## CHAFE SLEEVE (TECHNORA®)



**Diameters:** 8mm – 24mm  
**Cover:** 32 plait | 48 plait | Technora®  
**Colours:** Black  
**Application:** High temperature or friction areas

48 Plait construction allows this cover to open up easily, making it perfect additional rope cover. Excellent heat resistance and high co-efficient of friction make this a good protective cover for heat prone areas or as an aid to technical splices.

## LASHLINE



**Diameters:** 2.5mm – 10mm  
**Cover:** 16 plait | Dyneema® SK99  
**Coating:** SiliconCoat  
**Colours:** White  
**Application:** Lashings and strops

DIAMETER (mm)	2.5	3	3.5	4	5	6
BREAK LOAD (kg)	798	1770	2060	2390	2710	4450
WEIGHT (kg/100m)	0.31	0.62	0.77	0.93	1.09	1.71

DIAMETER (mm)	7	8	10	12	14	16
BREAK LOAD (kg)	5990	7490	11900	13420	15640	23200
WEIGHT (kg/100m)	2.43	2.94	4.65	6.71	7.82	11.60

Designed specifically for lashings and custom made loops. Lashline offers exceptional efficiency thanks to it's low twist construction and silicon coating. The coating allows each leg of the lashing or loop to slide and bed in, perfectly distributing the load to maximise breaking efficiency.

## WHIPPING TWINE (DYNEEMA®)



**Diameters:** 0.9mm & 1.1mm  
**Construction:** Dyneema®  
**Colours:** White, black, red, blue, green, yellow  
**Application:** Various

Whipping twine is available in 2 diameters and 2 lengths:  
 0.9mm - 50m spools  
 1.1mm - 25m spools



# COATINGS

As rope technology moves forward, it is coatings and the application of coatings that have been one of the biggest advancements in recent years. Different types of coatings are now being used to impart different properties to a rope. This may be because the coating offers properties that traditional fibre material cannot offer or perhaps the coating replicates the attributes of certain fibres but with less mass, thereby saving weight and reducing rope size.

## ARMOURCOAT

ArmourCoat is a pre-mixed polyurethane emulsion rope coating which increases abrasion resistance.

## SILICONECOAT

A silicone coating that lubricates the rope and reduces friction to improve internal abrasion resistance, and yarn-on-yarn abrasion.

## DRI COAT

A hydrophobic coating that repels water to reduce the water uptake of the rope.

## GRIPCOAT

A tacky self-healing coating that improves core-cover adhesion and reduces particle ingress into the rope.

## ENDURACOAT

A higher performing and premium polyurethane emulsion that significantly increases abrasion resistance.



# CUSTOMISATIONS

The identification of ropes is fundamental on board racing yachts especially aboard shorthanded boats. Grand Prix Series covers are custom made and can be specified with custom colours and fleck patterns to distinguish ropes for different on board applications, helping to improve crew efficiency.

## COLOUR CUSTOMISATION

POLYESTER YARN STANDARD COLOURS AVAILABLE:



BEIGE



BLACK

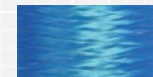

BLUE



GREEN

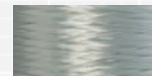

GREY



LIME



ORANGE



PINK

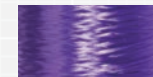

PURPLE

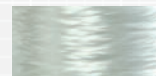

WHITE



GOLD



RED

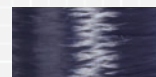

NAVY BLUE

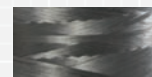

GRAPHITE

TECHNICAL FIBRES:

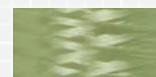

ARAMID

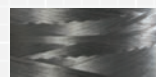

TECHNORA BLACK



TECHNORA BEIGE



VECTRAN



PBO

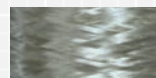

PEEK



WHITE DYNEEMA

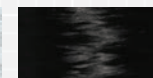

BLACK DYNEEMA

## HOIST MARKERS



Countdown hoist markers are added to the cover during braiding and assist grinders in timing sail hoist perfectly. Hoist markers will use the same material blends as the rest of the rope to maintain cover stability.

## GLOW IN THE DARK MARKERS



Glow in the dark or retro-reflective markers can be used along the full length of the rope to improve rope identification and visibility at night.

## DIAMETER INCREASE



Core inserts are precisely positioned before cover braiding and increase rope diameter at a specific point on the rope. Inserts not only increase rope diameter, but also help maintain rope shape for improved clutch and jammer performance.

## CUSTOM TAPERS



Cores can be tapered before the cover is over braided. The cover construction is then subtly altered during braiding to form an invisible rope taper. Core tapering decreases rope weight and improves flexibility on light tails.

## VARIABLE COVER BRAIDS

Different properties such as greater firmness, more flexibility or improved splicability can be imparted along the length of a single rope, using Marlow's variable cover braid technology.



# SUPERYACHT SERIES

*When managing the technical challenges, quality requirements and tight deadlines of the world's largest superyachts, we need a partner who we can work with to meet the customers' exacting demands and high expectations. Marlow with their Superyacht Series are able to deliver on all levels.*

ED DANBY, DIRECTOR MARINE RESULTS

Marlow's Superyacht Series draws upon our experience and success gained from the international race boat market. The Superyacht Series is a range of running rigging and mooring lines designed and custom made to the exacting specifications of Superyachts and Megayachts. Manufactured without compromise, the Superyacht Series offers customised quality, performance, aesthetics and innovation unrivalled in the industry.



# SUPERYACHT PROJECTS & TECHNOLOGY

## TECHNOLOGY

**SUPER HIGH STRENGTH:** Our range of Dyneema® SK99 ropes provide higher break loads for a given diameter, meeting the increasing demands on running rigging for higher loads and increased safety factors.

**BESPOKE COLOUR WAYS:** With 20 different colours and countless combinations of blends, flecks and patterns, Marlow running rigging can be customised to exacting cosmetic specifications to match the aesthetics of the yacht.

**CUSTOM MATERIAL BLENDS:** Different blends of exotic materials developed from the racing success of the Grand Prix Series, offer improved longevity and enhanced handling and abrasion characteristics.

**CAPTIVE WINCHES:** Dyneema® SK78 XBO: XBO Improves resistance to flex fatigue by a factor of 5 over standard SK78. On captive winches where ropes experience multiple cycles over the same section, XBO treatment can significantly extend rope life.

**CUSTOM TAPERS:** Custom tapered cores to exacting length specifications, combined with machine-tapered covers offer significant weight savings and improved flexibility on light tails.

**MACHINE FINISHED SPLICES:** For the perfect finish, we work with our Grand Prix Rigging and Superyacht rigging partners to supply machine finished splices that improve the splice aesthetics and help to reduce the splice diameter.

## PROJECTS

Full and partial running rigging and mooring ropes through our Superyacht partners

**ANNATTA**  
66M DUBOIS

**ADELA**  
55M DYKSTRA

**SEVEN**  
60M PARINI NAVI

**SKADE**  
46M HOLLAND YACHTBOUW

**SEAHAWK**  
59M PERINI NAVI

**ATHOS**  
62M HOEK

**ANNAZINE**  
110' DYKSTRA

**SEALYON**  
42M VIAREGGIO

**BLACK PEARL**  
106M OCEANCO

**FIDELIS**  
56M PERINI NAVI

**SEAHAWKE**  
60M PERINI NAVI

**PRANA**  
52M DUBOIS

**MY TACANUYA**  
56M SWIFTSHIPS

**RED DRAGON**  
52M ALLOY YACHTS

**AQUARIUS**  
47M PERINI NAVI

**PERSEUS 3**  
60M PERINI NAVI

**SALPERTON**  
45M DUBOIS

**MY LOLA**  
36M PEER GYNT

**KOKOMO**  
58M ALLOY

**FARFALLA**  
32M SOUTHERN WIND

**ZENJI**  
56M PERINI NAVI

**LADY B**  
45M DUBOIS

**MY LE CAPRICE III**  
PERSHING 90

**KNICKERBOCKER**  
35M PALMA JOHNSON

**SOJANA**  
34M GREEN MARINE

**THALIA**  
48M VITTARS

**CLEAR EYES**  
43M PAX NAVI

**AQUIJO**  
85M OCEANCO & VITTERS

**MY SONG**  
130' BALTIC

**G2**  
39M VITTARS

**REBECCA**  
42M GERMAN FRERS

**KENORA**  
32M LUCA BRENTA

**ADIX**  
65M

**NIKITA**  
115' BALTIC

**M5**  
75M VOSPER THORNEYCROFT

**SALUTE**  
56M PERINI NAVI

**WISP**  
47M ROYAL HUISMAN

**JANICE OF WYOMING**  
39M ALLOY

**MALTESE FALCON**  
88M PERINI NAVI

**CHRISTOPHER**  
46M PENDENNIS

**SILENCIO**  
50M PERINI NAVI

**VIJONARA**  
38.8M HOEK

**ELFJE**  
52M ROYAL HUISMAN

**HYPERION**  
47M ROYAL HUISMAN

**VALQUEST**  
40M DUBOIS

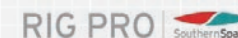





# RUNNING RIGGING

## D12

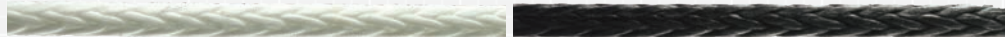

**Construction:** 12 Strand Dyneema®  
**Material:** Dyneema® SK78 or SK99, both with Marlow ArmourCoat. Dyneema® SK99 offers approximately 20% strength improvement over standard SK78 whilst maintaining similar creep properties  
 Colours: Black or White  
**Applications:** Uncovered lines including halyards on hydraulic rams, lashings, strops, cascades and wire replacement.

### D12 PLUS

DIAMETER (mm)	11	12	13	15	16	18	20	22	24	28	32	36	40	44	48
BREAK LOAD 99 (t)	13.8	15.2	18.4	21.4	24.5	29.2	38.9	57.4	63.0	83.0	109	126	155	180	207
BREAK LOAD 78 (t)	11.6	12.8	15.9	18.4	21.1	25.2	33.5	48.3	53.0	69.7	92	106	130	151	174
WEIGHT (kg/100m)	5.82	6.5	8.00	9.80	11.8	14.3	18	28.9	31.8	43.4	57.8	69.4	86.8	104	122

## SUPERYACHT D2

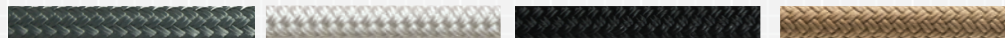

These are a representation of some of the customised ropes that we can provide for superyachts, solid colours and other variations are available.

**Core Construction:** 12 Strand pre-stretched Dyneema®  
**Core Material:** Dyneema® SK78 or SK99, both with Marlow ArmourCoat. Dyneema® SK99 offers approximately 20% strength improvement over standard SK78 whilst maintaining similar creep properties  
**Cover Construction:** 24 or 32 Plait Polyester cover available in custom colours to order  
**Applications:** Excellent all round rope for most on-board applications. Superyacht D2 is strong and flexible making it ideal for halyards, sheets, guys, control lines, reefing lines.  
**Extras:** Customised, length and colours for a bespoke finish. Available with machine finished splices for additional security and aesthetics.

DIAMETER (mm)	12	14	16	18	20	22	24	28	30	32
BREAK LOAD 99 (t)	8.26	11.0	15.2	18.4	21.4	24.5	29.2	38.9	46.2	48.8
BREAK LOAD 78 (t)	6.94	9.27	12.8	15.9	18.4	21.1	25.2	33.5	38.8	41.0
WEIGHT (kg/100m)	9.29	11.7	16.6	18.5	23.7	29.8	38.3	47.8	54.9	63.1

## SUPERYACHT D2 GRAND PRIX



**Core Construction:** 12 Strand pre-stretched Dyneema®  
**Core Material:** Dyneema® SK78 or SK99, both with Marlow ArmourCoat. Dyneema® SK99 offers approximately 20% strength improvement over standard SK78 whilst maintaining similar creep properties  
**Cover Construction:** 24 or 32 Plait Technora® / Polyester blend, cover available in custom colours to order  
**Applications:** Excellent all round rope for most on-board applications. Superyacht D2 Grand Prix offers additional abrasion and heat resistance over stand polyester covers. As with S/Y D2, the rope is strong and flexible making it ideal for most applications  
**Extras:** Customised, length and colours for a bespoke finish. Available with machine finished splices for additional security and aesthetics.

DIAMETER (mm)	12	14	16	18	20	22	24	28	30	32
BREAK LOAD 99 (t)	8.26	11.0	15.2	18.4	21.4	24.5	29.2	38.9	46.2	48.8
BREAK LOAD 78 (t)	6.94	9.27	12.8	15.9	18.4	21.1	25.2	33.5	38.8	41.0
WEIGHT (kg/100m)	9.29	11.7	16.6	18.5	23.7	29.8	38.3	47.8	54.9	63.1

## D12 MAX



**Construction:** 12 Strand Super pre-stretched Dyneema®  
**Material:** Dyneema® SK78 or SK99, both with Marlow ArmourCoat. Dyneema® SK99 offers approximately 20% strength improvement over standard SK78 whilst maintaining similar creep properties  
 Colours: Black or White  
**Applications:** Extreme high load or where lines are diameter critical or require higher safety factors. Uncovered lines including halyards on hydraulic rams, lashings, strops, cascades and wire replacement.

DIAMETER (mm)	9	10	11	12	13	15	17
D12 MAX 99 BREAK LOAD (t)	12.5	14.6	17.5	20.9	24.5	30.7	38.1
D12 MAX 78 BREAK LOAD (t)	10.8	12.6	15.1	18.0	21.1	26.4	32.9
WEIGHT (kg/100m)	5.40	6.30	7.55	9.00	10.7	13.4	18.4

## SUPERYACHT V2



**Core Construction:** 12 Strand Vectran®  
**Core Material:** Vectran® with Marlow ArmourCoat  
**Cover Construction:** 24 or 32 Plait Polyester cover available in custom colours to order  
**Applications:** Excellent for applications requiring zero creep where UV exposure can be managed – halyards  
**Extras:** Customised, length and colours for a bespoke finish. Available with machine finished splices for additional security and aesthetics.

DIAMETER (mm)	12	14	16	18	20	22	24
BREAK LOAD (t)	8.68	11.0	12.0	14.7	18.4	22.7	25.1
WEIGHT (kg/100m)	10.7	13.4	17.1	22.1	27.3	33.8	42.5

### KEY

-  **HIGH STRENGTH**
-  **LIGHT WEIGHT**
-  **LOW STRETCH**
-  **HIGH ABRASION RESISTANCE**
-  **LOW WATER ABSORPTION**
-  **HIGH FLEX/SOFT HANDLING**







# OCEANUS



## OCEANUS

DIAMETER: 14-70mm

32 PLAIT DYNEEMA®/TECHNORA® COVER | DYNEEMA® CORE

APPLICATION : **CAPTIVE WINCH**



The new Oceanus has been re-designed from the core up with a swap from 24 plait to 32 plait construction which allows a thinner cover and therefore a larger core to be used. This provides greater strength and improved factors of safety in applications where size is constrained. The core design has also been re-engineered to improve splicing and provide greater resistance to bending and compression fatigue.

**Core Construction:** 12 Strand long lay Dyneema® SK78.

**Also available in:** SK99: Up to 20% stronger than SK78 for high load applications. Marlow GripCoat for core/cover adhesion. SK78 cores available with "XBO fibre treatment" for improved flex fatigue resistance.

**Cover Construction:** 32 plait Dyneema® and Technora® Blend for excellent abrasion and heat resistance. Custom made to length with factory spliced and over-braided terminations to eliminate the possibility of splice induced cover slack. Lines made to exact specifications for diameter critical applications.

**Applications:** Specifically designed for captive winch applications to overcome typical problems, including, diameter critical winch drums, cover slack build up, high abrasion and friction induced heat damage.

**Specialist Coating:** Cores are coated with Marlow GripCoat to enhance cover adhesion, thereby eliminating cover slip which can be induced by captive winches, causing damage to rope and winch.

### 32 PLAIT

DIAMETER (mm)	22	24	26	28	30	32	34
BREAK LOAD (t) SK78	35.0	40.2	50.0	59.7	66.8	73.8	80.7
BREAK LOAD (t) SK99	41.7	47.9	59.5	71.0	79.5	87.8	96.1
WEIGHT (kg/100m)	30.5	34.9	48.5	57.2	61.3	68.7	72.7

DIAMETER (mm)	36	38	40	42	44	46	48	50
BREAK LOAD (t) SK78	94.9	102	108	115	128	142	156	169
BREAK LOAD (t) SK99	113	121	129	137	153	169	186	202
WEIGHT (kg/100m)	85.8	94.8	103.8	111.2	122.6	135.7	148.7	163.5

## OCEANUS CASE STUDY

Superyacht rigging specialists Marine Results asked Marlow to work with them to overcome technical challenges they were facing with the ropes on the 66m Dubois, Anatta (ex Aquido / Ahimsa)

Counteracting forces and frequent cyclic bending from the captive winches created cover slip in the existing ropes. The excess and baggy cover resulted in damage to the ropes as well as hampering the smooth running of the winches.

In addition, very high loads combined with a 3:1 factor of safety caused issues with rope diameter limitations from winches and deck gear. This was especially so along the tail of the splices which were required to exit through a specific and unchangeable diameter hole in the mast.

Our Technical Sales and Engineering teams worked closely with the team at Marine Results to specify and manufacture a rope that solved these issues within the timescales.

It was decided to use Oceanus, with its specially coated core to aid core / cover interaction and reduce coverslip. The specially designed SK99 core helped achieve the necessary break loads and the Dyneema® and Technora® blended cover gave the right compromise of grip and abrasion resistance to ensure smooth and efficient running on and off the winches. These design and manufacturing processes produced a rope within the diameter tolerances of the winches.

Finally Marine Results' own splicers worked with our rope technicians to produce machine finished splices that improved splice strength and aesthetics whilst helping to minimise diameter increase at the neck and along the tail.

The results of this teamwork were custom made ropes that met the tough application demands and the high expectations of the customer.

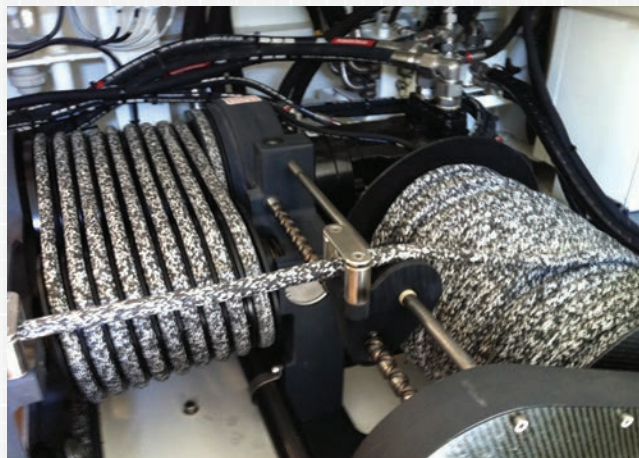

# MOORING

## MARINA GRANDE DOCKLINE

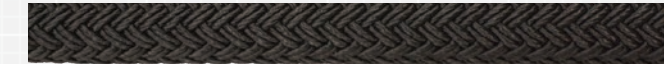

DIAMETER: 24-64mm

24 PLAIT COVER | POLYESTER | OPTI TWIST DOUBLEBRAIDED CONSTRUCTION

APPLICATION : **MOORING**

DIAMETER (mm)	24	28	32	36	40	44	48	52	56	60	64
BREAK LOAD (t)	10.9	15.5	20.7	26.5	32.7	37.7	46.0	52.6	63.7	70.3	83.0
WEIGHT (kg/100m)	39.1	55.8	73.9	95.1	118	135	165	189	229	252	298

Shock absorbing polyester opti-twist core with a tough polyester cover. Manufactured from Opti-twist polyester to give excellent extension and shock absorbing properties.

## SPliced LEATHERED EYES, COLOUR CODED WHIPS

APPLICATION : **MOORING**

Marlow's Superyacht Docklines can be custom ordered to length with factory spliced & leathered eyes and colour coded whips for easy identification.



## SUPERYACHT FENDERLINE



16 & 24 PLAIT | POLYESTER COVER

APPLICATION : **MOORING**

DIAMETER (mm)	12	14	16	18	20
BREAK LOAD (kN)	3420	5060	7250	8010	9490
WEIGHT (kg/100m)	9.9	14.2	16.8	22.0	24.0

Shock Absorbing Core, Abrasion Resistance, Easily Spliced, Comfortable to Handle.

## DYNALINE



12 STRAND DYNEEMA® SK75

APPLICATION : **WINCHING**

DIAMETER (mm)	6	8	9	10	11	12
BREAK LOAD (t)	3.13	6.34	7.64	9.53	11.70	13.40
WEIGHT (kg/100m)	1.6	3.1	3.8	4.86	5.71	6.64

Specially designed for winching, Dynaline offers a strong, safe and light alternative to wire on davits and cranes.



# CLASSIC SERIES

The Classic Series brings Marlow's knowledge of high-tech, performance running rigging from our Grand Prix Series and Standard Range to traditional and classic yachts.

As well as looking beautiful, many classics are hard racers and classic racing is every bit as competitive as their modern counterparts. These seasoned racers demand the latest running rigging technology without compromising the yacht's aesthetics.

The solid white and natural colours of the Classic Series mask the use of exotic materials and high tech manufacturing processes, blending perfectly with the teak decks, wooden spars and polished fittings of any classic craft.



# CLASSIC PROJECTS

## CLASSIC RIGGING

Classic yachts have traditionally used wire or rope-to-wire halyards. However, modern materials and greater sympathy towards the look of classic yachts means that more and more classic yacht owners are moving to synthetic fibre and away from traditional wire halyards.

The benefits of synthetic rope over steel wire are significant and the reason why most cruising yachtsmen no longer see wire as relevant, especially considering the advancements in sailcloth.

- Significant weight saving
- Performance improvements
- Easier to handle
- No wire splinters
- No rope-to-wire splicing required
- Easier to eye splice
- Improved safety
- Easier to maintain
- Longer lasting
- Reduced chafe on sails and gear

Some classics continue to use traditional natural fibre ropes such as sisal or manila. Modern synthetic ropes can replicate the look of these traditional products but with significantly improved reliability and longevity.

Using a mixture of Dyneema® and polyester ropes to balance performance improvements with the peculiarities of old boats made with old materials, is the skill of the classic rigger.

The table below compares to break loads and weights of Marlow:

DIA.	7X19 STAINLESS WIRE		DOUBLEBRAID		V2		D2 78		D12 99*	
	BREAK LOAD	MASS (kg/100m)	BREAK LOAD	MASS (kg/100m)	BREAK LOAD	MASS (kg/100m)	BREAK LOAD	MASS (kg/100m)	BREAK LOAD	MASS (kg/100m)
5mm	-	-	-	-	-	-	-	-	2800	1.28
6mm	2356	13.4	1390	2.84	1678	2.77	2056	2.41	4150	1.28
7mm	-	-	-	-	-	-	-	-	6380	2.80
8mm	4181	24.3	2560	4.80	3350	4.89	3490	3.90	7530	2.80
9mm	-	-	-	-	-	-	-	-	8260	3.76
10mm	6536	37.9	3690	7.47	5750	6.65	5360	5.92	11000	5.82
11mm	-	-	-	-	-	-	-	-	13800	5.82
12mm	9412	57.8	4760	11.1	8680	10.7	6940	9.29	15200	6.5w
13mm	-	-	-	-	-	-	-	-	18400	8.00
14mm	12808	76.8	6050	15.6	11000	13.4	9270	11.7	-	-

\* Diameters used for D12 99 comparisons are 1mm smaller than those detailed for the other products in this table

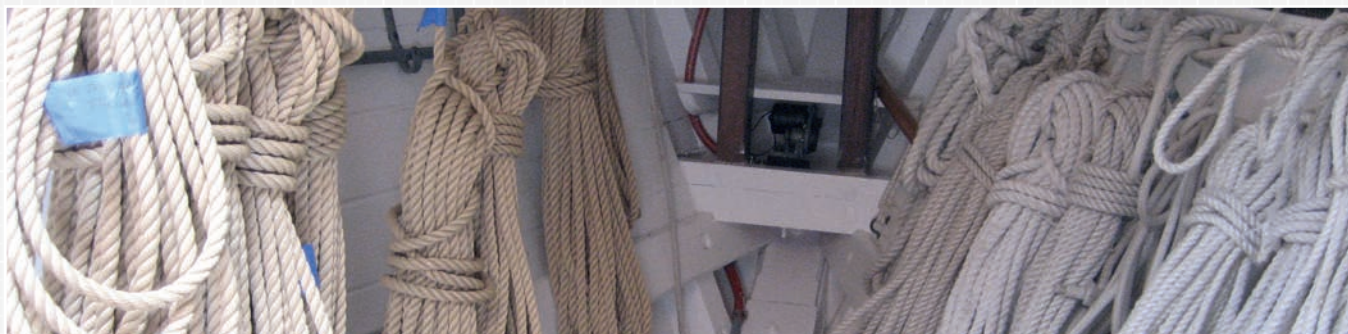

## PROJECTS

Full and partial running rigging and mooring ropes through our Classic Rigging Partners

**MARALEE**  
**SONNY - BROOKLYN BOAT YARD**  
**ANNA-LYMAN MORSE**  
**MOONBEAM IV**  
**HALLOWEEN**  
**TUIGA**  
**HISPANIA**  
**ALTAIR**  
**MARIETTE**  
**EILEAN**  
**AVEL**  
**CREOLE**

**SHENNANDOAH**  
**ADIX**  
**ARGYLL**  
**IKRA**  
**STORMY WEATHER**  
**KELPIE OF FALMOUTH**  
**MANITOU**  
**ENTERPRISE**  
**KILENA OF CORSICA**  
**FAIR LADY**  
**SOVEREIGN**  
**MOONBEAM III**

**SO FONG**  
**GIRALDILLA MARCONI**  
**TERN**  
**LATIFA**  
**THE LADY ANNE**  
**ANGELITA**  
**VARUNA**  
**COMET**  
**SPIRIT YACHTS**  
**MARISKA**  
**SEVEN SEAS**

# HIGH TECH CLASSICS

## D2 GRAND PRIX

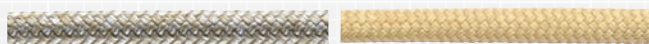

**Construction:** 12 strand Dyneema® SK78 Core\*  
24 Plait MGP Tech50 Cover

**Applications:** Halyards, Sheets, Guys, Control lines, Out/Down hauls, Reefing lines, Runner-tails, Vang, Furlers

DIAMETER (mm)	8	10	12	14	16
<b>BREAK LOAD (kg)</b>	3490	5360	6940	9270	12800
<b>WEIGHT (kg/100m)</b>	3.90	5.92	9.29	11.7	16.6

50/50 Technora® / Polyester cover provides even greater performance in clutches, jammers and around winches. The cover improves heat resistance, grip and abrasion resistance compared to D2 Racing 78. Cores can be colour coded to match cover for a more traditional look.  
\* Large diameters and alternative core options are available, including D12 78 Max, D12 99 & D12 Max 99

## D2 RACING 78

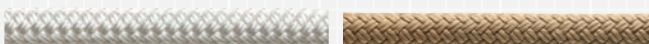

**Construction:** 12 strand Dyneema® SK78 core with 24 plait polyester cover  
**Applications:** Halyards, Sheets, Guys, Control lines, Out/Down hauls, Reefing lines, Runner-tails, Vang, Furlers

DIAMETER (mm)	8	10	11	12	14	16	18
<b>BREAK LOAD (kg)</b>	3490	5360	6330	6940	9270	12800	15900
<b>WEIGHT (kg/100m)</b>	3.90	5.92	6.9	9.29	11.7	16.6	18.5

Dyneema® SK78 core is light weight - reduces on-board weight and makes the rope easier to handle.

Dyneema® SK78 core is high strength - upgrade polyester halyards by choosing a smaller diameter and achieve further weight savings and handling improvements. Pre-stretching the core results in very low stretch - far fewer rig adjustments when sailing.

24 Plait Polyester jacket provides superior performance in clutches and jammers and gives excellent abrasion resistance and greater longevity. Easily spliced and tapered for a safer rig and further weight saving. Cores can be colour coded to match cover for a more traditional look. (see D12)

## V2 RACING



**Construction:** 12 strand Vectran® core with 24 plait polyester cover  
**Applications:** Halyards, Guys, Control lines, Out/Down hauls, Runnertails, Vang

DIAMETER (mm)	8	10	12	14	16	18
<b>BREAK LOAD (kg)</b>	3350	5750	8680	11000	12000	14700
<b>WEIGHT (kg/100m)</b>	4.89	6.65	10.7	13.4	17.1	22.1

No stretch or creep. No re-tensioning of halyards, maintaining perfect sail shape and trim. Polyester jacket provides superior performance in clutches and jammers and gives excellent abrasion resistance and greater longevity.

## D12



**Construction:** 12 strand  
**Material:** Dyneema® Available in SK99 and SK78  
**Extras:** Pre-Stretched, ArmourCoat  
**Features:** Light weight, low stretch & high strength. D12 78 & 99 demonstrate lower creep than other types of UHMWPE fibres.

DIAMETER (mm)	2.5	3	3.5	4	5	6	6.5	7	8	9
<b>SK99 BREAK LOAD (kg)</b>	677	1180	1710	2450	2800	4150	5280	6380	7530	8260
<b>SK78 BREAK LOAD (kg)</b>	569	995	1430	2060	2360	3490	4440	5360	6330	6940
<b>WEIGHT (kg/100m)</b>	0.37	0.53	0.74	0.98	1.28	1.77	2.20	2.80	3.30	3.76

DIAMETER (mm)	10	11	12	13	15	16	18	19	20	22
<b>SK99 BREAK LOAD (kg)</b>	11000	13800	15200	18400	21400	24500	29200	32700	38900	46200
<b>SK78 BREAK LOAD (kg)</b>	9270	11600	12800	15900	18400	21100	25200	27500	33500	38800
<b>WEIGHT (kg/100m)</b>	4.83	5.82	6.5	8.00	9.80	11.8	14.3	15.7	18.0	21.6

Lightweight, very strong - excellent for lashing and for metal shackle replacement. Marlow ArmourCoat, increases the life of the rope by increasing abrasion resistance. Does not absorb water so floats and remains light weight when sailing. Quick and easy to splice, less time preparing the boat, more time on the water.



# TRADITIONAL CLASSICS

## MARLOWBRAID

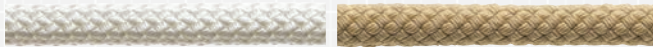

**Construction:** 3 Strand Polyester core with 16 plait polyester cover  
**Applications:** Halyards, Sheets, Guys, Control lines, Out/Down hauls, Reefing lines, Runner-tails, Vang, Furlers

DIAMETER (mm)	6	8	10	12	14	16	18	20
<b>BREAK LOAD (kg)</b>	986	1580	2850	4450	5460	7420	10200	11300
<b>WEIGHT (kg/100m)</b>	2.68	4.45	7.30	10.0	14.5	19.0	23.5	28.5

Twisted 3 strand core - gives excellent strength and lower stretch than braid on braid. Tough 16 plait polyester jacket - provides excellent abrasion resistance and longevity. Easily spliced - a great all round rope for most on board applications.

## 3 STRAND

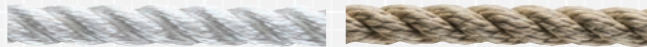

**Construction:** 3 Strand Polyester, pre-stretched  
**Applications:** Halyards, Control lines, General purpose

DIAMETER (mm)	8	10	12	14	16
<b>BREAK LOAD (kg)</b>	1730	2640	3490	4200	5700
<b>WEIGHT (kg/100m)</b>	5.40	8.00	12.3	16.5	19.0

Solid, pre-stretched, strong 3 strand line. Ideal for general purpose use as well as low stretch halyards.

## 8 PLAIT STANDARD



**Construction:** 8 plait Polyester  
**Applications:** Flag halyard, Leech lines, General lashing, Whipping

DIAMETER (mm)	1.5	2	3	4
<b>BREAK LOAD (kg)</b>	90	130	210	359

Solid polyester line, ideal for burgee and signal halyard, leech lines, as well as general lashings and decorative whipping. 2mm & 3mm white available in mixed packs of handy mini-spools.

## DOUBLEBRAID



**Construction:** 12 Strand Braided polyester core with 24 plait polyester cover  
**Applications:** Sheets, Guys, Control lines, Out/Down hauls, Runner-tails, Reefing lines, Vang, Furlers

DIAMETER (mm)	6	8	10	11	12	14	16	18
<b>BREAK LOAD (kg)</b>	1390	2560	3690	4370	4760	6050	7230	7910
<b>WEIGHT (kg/100m)</b>	2.84	4.80	7.47	8.87	11.1	15.6	19.3	23.2

A versatile rope that can be used on most applications on cruising boats. The braid on braid construction delivers a soft and flexible rope for easy handling.

## 3 STRAND POLYESTER



**Construction:** 3 Strand Polyester  
**Applications:** General Purpose, Mooring

DIAMETER (mm)	4	6	8	10	12	14
<b>BREAK LOAD (kg)</b>	529	1120	1530	2322	3015	3690
<b>WEIGHT (KG/100M)</b>	1.21	3.20	4.60	8.20	11.6	15.0
	<b>16</b>	<b>18</b>	<b>20</b>			
	4860	5850	6570			
	19.3	24.0	30.0			

The classic 3 strand line, Marlow's 3 Strand is manufactured using the highest quality materials to produce a rope with great flexibility and firmness. Polyester wont degrade in UV and remains supple and strong even when wet.

## WHIPPING TWINE

**Material:** Waxed Polyester  
**Lengths:** 41m, also available in bulk 1kg cops



Marlow's world famous whipping twine has a waxy finish to keep the whip secure.

DYNEEMA® WHIPPING TWINE ALSO AVAILABLE - SEE P14

## KEY

- HIGH STRENGTH
- LIGHT WEIGHT
- LOW STRETCH
- HIGH ABRASION RESISTANCE
- LOW WATER ABSORPTION
- HIGH FLEX/SOFT HANDLING



# CRUISER & RACER SERIES

*Reliability and performance are vital when racing across oceans, and Marlow D2 Racing 78 has consistently provided both on Clipper Race yachts throughout numerous circumnavigations. The service and support behind the product are also vital to the Clipper Fleet, and here again, Marlow Ropes have a proven track record of delivering with performance matching that of the product.*

**SIMON JOHNSTON, HEAD OF MAINTENANCE, THE CLIPPER ROUND THE WORLD YACHT RACE**



It goes without saying that when circumnavigating the globe in a race against 11 other yachts, the ropes on board experience the best and worst conditions that the Southern Ocean, Atlantic and Pacific have to offer.

However, the ropes supplied on all 12 Tony Castro design Clipper 70's are not super expensive, custom made ropes using exotic fibres and cutting edge manufacturing techniques. They are ropes that you will find in any chandlery around the world that stocks Marlow... and when they've completed 11 months of punishment, they're ready to do another 40,000 miles.

For the team at Clipper Ventures, hard racing is the name of the game, but so too is safety and durability – that is why they have chosen Marlow for their past 7 round the world races and for the 2017 -18 edition too.

Marlow's ropes have been tried and tested time and again in the toughest conditions imaginable, time and again they deliver.... performance, safety, durability.

If the ropes in this catalogue (available to any consumer on 6 continents around the world) are good enough to be chosen by the world's longest round the world yacht race year after year – what products would you recommend?



# RUNNING RIGGING DEFINITIONS

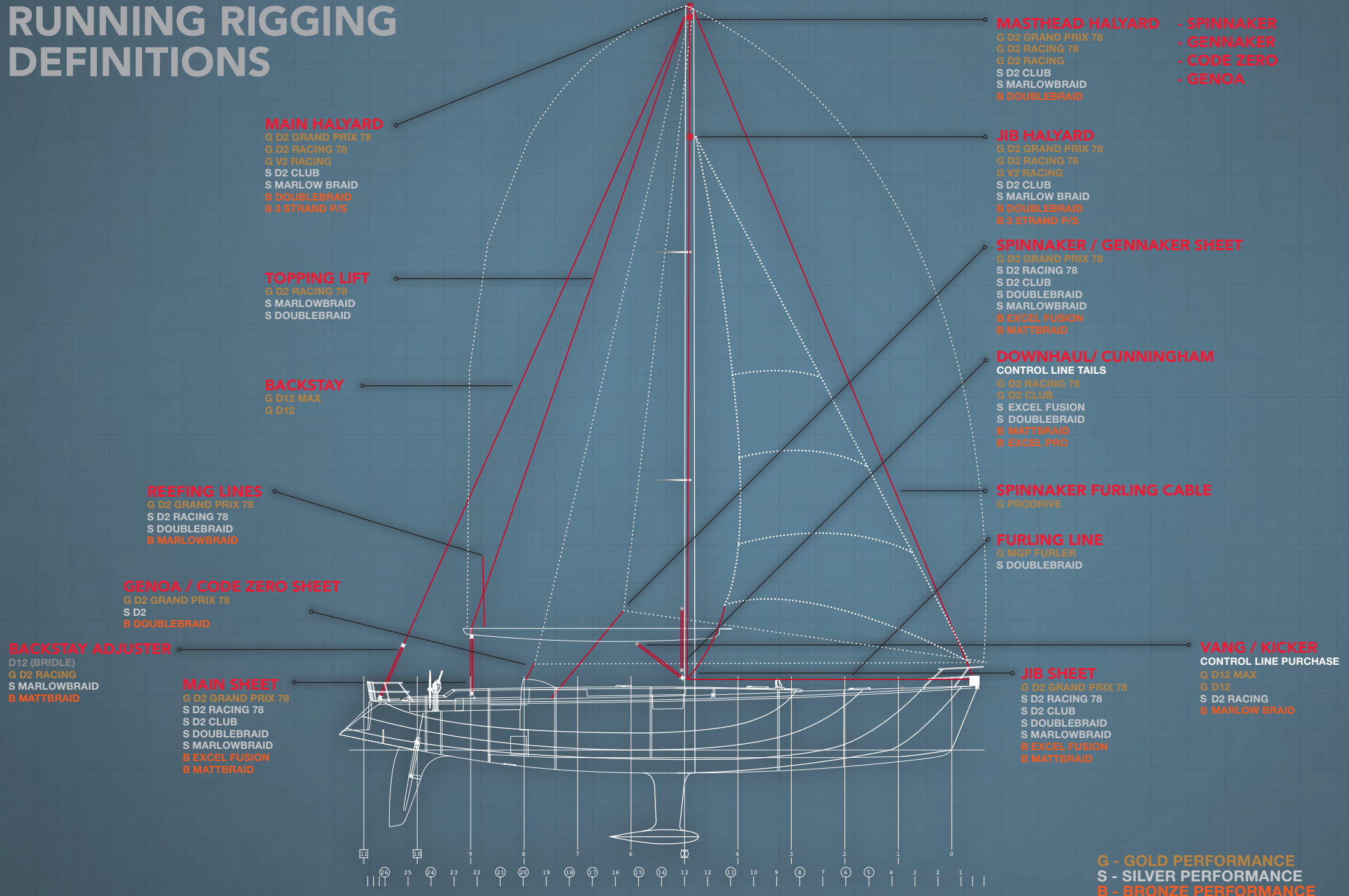

**MASTHEAD HALYARD** - SPINNAKER  
 - GENNAKER  
 - CODE ZERO  
 - GENOA  
 G D2 GRAND PRIX 78  
 G D2 RACING 78  
 G D2 RACING  
 S D2 CLUB  
 S MARLOWBRAID  
 B DOUBLEBRAID

**MAIN HALYARD**  
 G D2 GRAND PRIX 78  
 G D2 RACING 78  
 G V2 RACING  
 S D2 CLUB  
 S MARLOW BRAID  
 B DOUBLEBRAID  
 B 3 STRAND P/S

**JIB HALYARD**  
 G D2 GRAND PRIX 78  
 G D2 RACING 78  
 G V2 RACING  
 S D2 CLUB  
 S MARLOW BRAID  
 B DOUBLEBRAID  
 B 3 STRAND P/S

**TOPPING LIFT**  
 G D2 RACING 78  
 S MARLOWBRAID  
 S DOUBLEBRAID

**SPINNAKER / GENNAKER SHEET**  
 G D2 GRAND PRIX 78  
 S D2 RACING 78  
 S D2 CLUB  
 S DOUBLEBRAID  
 S MARLOWBRAID  
 B EXCEL FUSION  
 B MATTBRAID

**BACKSTAY**  
 G D12 MAX  
 G D12

**DOWNHAUL/ CUNNINGHAM CONTROL LINE TAILS**  
 G D2 RACING 78  
 G D2 CLUB  
 S EXCEL FUSION  
 S DOUBLEBRAID  
 B MATTBRAID  
 B EXCEL PRO

**REEFING LINES**  
 G D2 GRAND PRIX 78  
 S D2 RACING 78  
 S DOUBLEBRAID  
 B MARLOWBRAID

**SPINNAKER FURLING CABLE**  
 G PRODRIVE

**GENOA / CODE ZERO SHEET**  
 G D2 GRAND PRIX 78  
 S D2  
 B DOUBLEBRAID

**FURLING LINE**  
 G MGP FURLER  
 S DOUBLEBRAID

**BACKSTAY ADJUSTER**  
 D12 (BRIDLE)  
 G D2 RACING  
 S MARLOWBRAID  
 B MATTBRAID

**VANG / KICKER CONTROL LINE PURCHASE**  
 G D12 MAX  
 G D12  
 S D2 RACING  
 B MARLOW BRAID

**MAIN SHEET**  
 G D2 GRAND PRIX 78  
 S D2 RACING 78  
 S D2 CLUB  
 S DOUBLEBRAID  
 S MARLOWBRAID  
 B EXCEL FUSION  
 B MATTBRAID

**JIB SHEET**  
 G D2 GRAND PRIX 78  
 S D2 RACING 78  
 S D2 CLUB  
 S DOUBLEBRAID  
 S MARLOWBRAID  
 B EXCEL FUSION  
 B MATTBRAID

G - GOLD PERFORMANCE  
 S - SILVER PERFORMANCE  
 B - BRONZE PERFORMANCE







### D2 GRAND PRIX 78

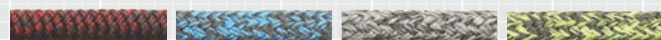

DIAMETER: 8-12mm  
12 STRAND DYNEEMA® SK78 COLOUR MATCHED CORE | 24 PLAID POLYESTER/TECHNORA® BLENDED COVER

APPLICATION : **HALYARDS** **SHEETS**

DIAMETER (mm)	8	10	12
BREAK LOAD (kg)	3490	5360	6940
WEIGHT (kg/100m)	3.90	5.92	9.29

The ultimate racing halyard available with D12 78 or D12 99 core for additional strength. Lightweight, low stretch, minimal creep with grippy, abrasion resistant cover for excellent jammer performance. Also perfect as a high performance sheet. Lightweight and taper-able with blended cover that grips well on winch drums and lasts during the toughest races thanks to its high melting point.

### D2 CLUB

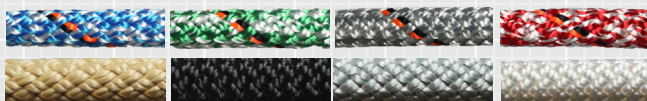

DIAMETER: 8-14mm  
12 STRAND DYNEEMA® SK38 CORE | 16 PLAID POLYESTER COVER

APPLICATION : **HALYARDS** **SHEETS** **CONTROL LINE TAILS**

DIAMETER (mm)	8	10	12	14
BREAK LOAD (kg)	2190	3780	5200	7400
WEIGHT (kg/100m)	4.14	6.98	8.76	12

D2 Club has been developed to provide an upgrade to Polyester sheets and halyards offering the benefit of reduced weight and reduced elongation thanks to the light weight Dyneema SK38 core. Due to the ropes equivalent strength and diameter to typical Polyester braids, it can be simply substituted without the complexity and expense of having to modify or change deck equipment like clutches and winches.

### V2 RACING



DIAMETER: 8-18mm  
12 STRAND VECTRAN® CORE | 24 PLAID BRAIDED POLYESTER COVER

DIAMETER (mm)	8	10	12	14	16	18
BREAK LOAD (kg)	3350	5750	8680	11000	12000	14700
WEIGHT (kg/100m)	4.89	6.65	10.7	13.4	17.1	22.1

The same hardwearing cover as used on the D2 Racing covers our V12 Vectran core. Vectran offers zero creep and minimal elongation meaning no re-tensioning of halyards is ever needed, even on long tacks when sailing offshore. As with D2 Racing, the cover provides excellent abrasion resistance along with superior performance in clutches and jammers.

### D2 RACING 78



DIAMETER: 8-18mm  
12 STRAND DYNEEMA® SK78 COLOUR MATCHED CORE | 24 PLAID POLYESTER COVER

APPLICATION : **HALYARDS** **SHEETS** **CONTROL LINE PURCHASE**

DIAMETER (mm)	8	10	11	12	14	16	18
BREAK LOAD (kg)	3490	5360	6330	6940	9270	12800	15900
WEIGHT (kg/100m)	3.90	5.92	6.9	9.29	11.7	16.6	18.5

Light weight, low stretch and high strength using a colour coded D12 78 core. Use a size smaller than with a polyester halyard thanks to high break loads. Easily tapered, hard wearing cover grips well in clutches. Also use as a lightweight, high strength sheet that can be tapered to reduce weight on clew. The brightly coloured polyester cover is easily identifiable and runs smoothly, gripping well on winches and cleats. A perfect solution for high strength, light-weight all-round control line applications.

**NEW MOTTLED COVERS NOW AVAILABLE IN BLACK, BLUE, GREEN, LIME ORANGE & RED**

### D12



DIAMETER: 7-15mm  
12 STRAND DYNEEMA® SK78 - ALSO AVAILABLE IN SK99 FOR HIGHER STRENGTH

APPLICATION : **CONTROL LINE PURCHASE**

#### SK78:

DIAMETER (mm)	2.5	3	4	5	6	7
BREAK LOAD (kg)	569	995	2060	2360	3490	5360
WEIGHT (kg/100m)	0.37	0.53	0.98	1.28	1.77	2.80

#### SK99:

DIAMETER (mm)	2.5	3	4	5	6	7
BREAK LOAD (kg)	677	1180	2450	2800	4150	6380
WEIGHT (kg/100m)	0.37	0.53	0.98	1.28	1.77	2.80

Lightweight and high strength, single braid Dyneema® with tough ArmourCoat finish. Excellent for lashings and metal shackle replacement. Best option for wire replacement on a number of applications including cascade purchase systems. Diameters can be reduced for all control line applications from those used for polyester ropes thanks to its high break loads.

### DOUBLEBRAID

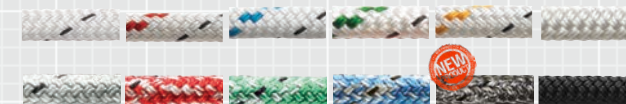

DIAMETER: 6-18mm  
12 STRAND POLYESTER CORE | BRAIDED POLYESTER 24 PLAID COVER

APPLICATION : **HALYARDS** **SHEETS** **CONTROL LINE PURCHASE**

DIAMETER (mm)	6	8	10	11	12	14	16	18
BREAK LOAD (kg)	1390	2560	3690	4370	4760	6050	7230	7910
WEIGHT (kg/100m)	2.84	4.80	7.47	8.87	11.1	15.6	19.3	23.2

Our heat set Doublebraid offers industry leading strength and stretch performance for a polyester braid-on-braid. Flexibility and soft feel ensures easy handling around the boat, making this rope ideal for sheets. Easy splicing removes the need for bulky knots at the clew of the sail, which also reduce a ropes strength. Also good for halyards thanks to the heat setting process helping to reduce stretch. Use for most on board applications.

**NEW MOTTLED GRAPHITE COVER NOW AVAILABLE**





### M-RIG MAX



**Construction:** 12 strand  
**Material:** Dyneema® DM20  
**Extras:** Marlow's Super Pre-Stretch process, ArmourCoat  
**Features:** Ultimate low creep, light weight rope.

DIAMETER (mm)	2.5	3	4	5	6	7	8	9	10	11	12	13	15	17
<b>BREAK LOAD (kg)</b>	902	1350	2220	2870	4110	6740	8430	9690	11300	13600	16200	19000	23700	29500
<b>WEIGHT (kg/100)</b>	0.45	0.68	1.11	1.56	2.23	3.56	4.45	5.40	6.30	7.55	9.00	10.7	13.4	18.4

M Rig Max's top benefit is minimal creep ideal for standing rigging and steering lines. Add an MGP cover or light weight chafe cover for high wear applications such as life lines.

### M-RIG MAX – SYNTHETIC FIBRE STANDING RIGGING FOR THE CRUISER / RACER

M-Rig Max uses Dyneema's DM20 Max Technology yarn. DM20 exhibits zero creep meaning that it lends itself for use as super lightweight standing rigging. Every kilogram saved aloft equates to a 5-7kg saving at the keel, as well as reduced pitching in a head sea.

Marlow's M-Rig Max brings creep free fibre standing rigging within reach of everyday yachtsmen. Traditionally, fibre standing rigging has been incredibly expensive thanks to the use of Zylon® (PBO) in a custom-made cable configuration. M-Rig Max uses DM20 and Marlow's Max Pre-Stretching technology to produce a rope that is available to any rigger on a reel.

1. Measure the rig
2. Cut M-Rig Max to length
3. Use simple locking D12 Splice with lashing thimbles
4. Secure and tension using Marlow Lashline (page 14)

The lower modulus of Dyneema® DM20 means that even with Marlow's Max Pre-Stretching, to match the stretch exhibited by wire (as measured by mm/mm/1000kg) a larger diameter will be required.

The table also demonstrates that not only is M-Rig Max lighter, it is also 5x stronger than wire for a given stretch factor. Significant strength advantage means that if the initial elastic elongation experienced by Dyneema can be managed (see page 8), a smaller diameter of M-Rig Max can be specified.

The choice of M-Rig Max diameter is a balance between ultimate strength and manageable elongation.

#### KEY

-  HIGH STRENGTH
-  LIGHT WEIGHT
-  LOW STRETCH
-  HIGH ABRASION RESISTANCE
-  LOW WATER ABSORPTION
-  HIGH FLEX/SOFT HANDLING





**M-RIG MAX CASE STUDY**

YACHT: J-BOATS J97 – 30' CRUISER RACER STANDARD RIGGING.

SECTION	MATERIAL	mm/mm/100kg	MBL (kg)	MASS g/m	LENGTH (m)	QTY
FORESTAY	-10 Rod	0.00200	4,670	249	12.99	1
TOP SHROUDS	7mm Compact Strand	0.00190	4,910	260	12.56	2
LOWERS	7mm Compact Strand	0.00190	4,910	260	4.82	2
INTERMEDIATE	6mm Compact Strand	0.00259	3,550	194	9.03	2
BACKSTAY	5mm 1x19 Stainless	0.00463	2,000	122	11.00	1
BACKSTAY V	5mm 1x19 Stainless	0.00463	2,000	122	3.72	2
TIE ROD	5mm 1x19 Stainless	0.00463	2,000	122	0.53	1

Total standing rigging weight: 18.09 kg (excluding terminations)

Discussions with the rigger suggest than approximately 50% additional elongation within the rig is acceptable and manageable. Windage is not an issue, therefore M-Rig Max is specified as follows:

SECTION	MATERIAL	mm/mm/100kg	MBL (kg)	MASS g/m	LENGTH (m)	QTY
FORESTAY	11mm M-Rig Max	0.00313	12,618	75.5	12.99	1
TOP SHROUDS	11mm M-Rig Max	0.00313	12,618	75.5	12.56	2
LOWERS	11mm M-Rig Max	0.00313	12,618	75.5	4.82	2
INTERMEDIATE	10mm M-Rig Max	0.00376	10,518	63	9.03	2
BACKSTAY	7mm M-Rig Max	0.00630	6,272	35.6	11.00	1
BACKSTAY V	7mm M-Rig Max	0.00630	6,272	35.6	3.72	2
TIE ROD	7mm M-Rig Max	0.00630	6,272	35.6	0.53	1

Total standing rigging weight: 5.47 kg (excluding terminations)

Our case study shows that by using M-Rig Max the total standing rigging is 70% lighter, saving 12.62 kg aloft, but is nearly 3 times as strong as the equivalent wire/rod rig.

If the rigger is able to manage the initial elastic elongation when installing M-Rig Max and the mast can manage the increased deflection during gusts, smaller diameters can be specified, further reducing both weight and windage. In our example above, a further 1.8 kg can be reduced from the rig by specifying M-Rig Max 2mm smaller.

A saving of 14.41 kg in the rig is equivalent to shaving 100kg off the bulb – and the rigging is stronger than with wire.

**PRODRIVE 2.0 - TORSIONAL FURLING CABLE**



DIAMETER (mm)	7	9	11	13	15
BREAK LOAD (kg)	2190	3440	5070	6870	7450
WEIGHT (kg)	4.47	6.67	9.84	13.6	18.1

**PRODRIVE OFFERS**

- FAST FURLING
- EASIER FURLING
- EVEN FURLING
- TOP DOWN FURLING
- FASTER SAIL CHANGES
- ECONOMIC OPTION FOR MULTIPLE HEAD SAILS
- INTEGRATES EFFORTLESSLY WITH ANY FURLING UNIT

Following the success of Marlow's original torsional cable, the **PRODRIVE 2.0** has been through an engineered evolution which sees a number of improvements to the core and cover resulting in a better performing rope product with improved rigidity and stiffness without increasing the cost.



Upgrades to the core include the high modulus aramid from the centre of the rope being replaced with a braided core firm filler which gives the centre of the rope more rigidity and durability. A benefit of the braided core is that this no longer 'knuckles' when bent and is then covered with a secondary load bearing aramid core.

The **PRODRIVE 2.0** has two additional braided jackets; the first continues to be made from aramid fibre to carry torsional load, and now the second braided jacket has been upgraded from polyester to black Dyneema® – a new addition to the DSM Dyneema® product range which wasn't available at the time of engineering PRODRIVE 1.0.

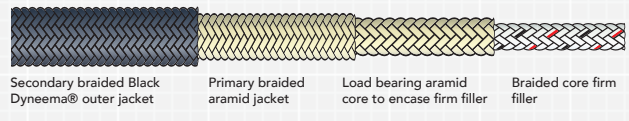

**MGP FURLER 50**



**POLYPROPYLENE CORE – 16 PLAIT VECTRAN® / POLYESTER SNAKE SKIN COVER. DIAMETER: 6-12mm**

Snake skin pattern allows easy end-to-end splicing with no diameter increase. Vectran® or Technora® cover ensures heat and abrasion resistance. Has a sacrificial Polypropylene core as standard, but can be up graded to a D12 core for higher load furling systems.

**MARLOWBRAID**



DIAMETER: 6-20mm  
 3 STRAND POLYESTER CORE | 16 PLAIT POLYESTER COVER  
 APPLICATION : **HALYARDS** **SHEETS** **CONTROL LINE PURCHASE**

DIAMETER (mm)	6	8	10	12	14	16	18	20
BREAK LOAD (kg)	986	1580	2850	4450	5460	7420	10200	11300
WEIGHT (kg/100m)	2.68	4.45	7.30	10.0	14.5	19.0	23.5	28.5

Our famous polyester line offers class leading low stretch for a polyester rope thanks to its laid 3-strand core construction, making Marlowbraid an ideal halyard rope. The tough 16-plait cover is hard wearing and grips well in clutches also offering great abrasion resistance on winches when used as a sheet. The low stretch core and tough cover makes Marlowbraid ideal for all control line applications such as cascades and vang.

**MATTBRAID**



DIAMETER: 6-16mm  
 12 STRAND POLYESTER CORE | 24 PLAIT POLYESTER COVER  
 APPLICATION : **SHEETS** **CONTROL LINE TAILS**

DIAMETER (mm)	8	10	12	14	16
BREAK LOAD (kg)	1120	1980	2810	3300	5430
WEIGHT (KG/100m)	5.00	7.00	9.90	12.6	17.8

Soft, flexible and easy on the hands, Mattbraid uses the same braid-on-braid construction as Doublebraid, but with the addition of a soft, spun polyester cover. Great feel and grip in the hands, especially when wet, Mattbraid is the ideal sheet for cruising applications where comfort is key.

**PS12**



DIAMETER: 4-6mm  
 12 STRAND PRE-STRETCHED POLYESTER  
 APPLICATION : **ACCESSORIES**

DIAMETER (mm)	4	5	6
BREAK LOAD (kg)	678	1060	1330
WEIGHT (kg/100m)	1.19	1.91	2.47

12 strand polyester can easily be spliced for halyard tails and lazy jacks.



# EXCEL DINGHY SERIES

*"The British Sailing Team and Marlow Ropes have always worked closely together on rope technology development and supply, and to ensuring that we have the best quality product on board our race boats. The innovation and reliability without compromise that they offer the team help our athletes stay at the top of our sport."*

MARK ROBINSON: OLYMPIC PERFORMANCE MANAGER, BRITISH SAILING TEAM.

"excel [ik'sel], verb – to surpass all others, to be superior (to others) or outstandingly good"

Marlow were the first manufacturer to produce a coordinated and complementary range of ropes specifically designed for dinghies and sports boats.

Far from being the little brother to yacht racers, at Marlow we understand that not only does dinghy sailing offer up some of the most exciting and closest racing, it is also the proving grounds for the next generation of grand prix racing superstars.

There can be no better endorsement than being the official rope supplier to the multi-gold medal winning British Sailing Team, and the rope of choice of countless other international and national class champions.

The Excel range is constantly updated with new products, improved specifications and the latest colours. Imitated by many, matched by none, the Excel Dinghy Series, developed in conjunction with the world's best sailors will help ensure success at every level of dinghy sailing.



# EXCEL SPONSORED TEAMS



**Official Supplier**

## BRITISH SAILING TEAM - OFFICIAL SUPPLIER

Marlow Ropes is the official supplier and exclusive team ropes partner to the British Sailing Team GBR, thanks to our industry-renowned reputation for producing innovative, race-winning products.

Marlow have been a supporter of the team for a number of years, supporting individual sailors directly as well as working with the team as a whole. Marlow and the British Sailing Team work closely together on rope technology development to ensure the best performing products on board the boats.

The team's successes in recent Olympic Games are well documented and Great Britain head the all time gold medal table in sailing events by quite some margin. We are extremely proud to have been associated with such a successful team for so long and in some small way to have helped with those successes.

The Marlow Ropes Award was introduced in 2002 with the aim of rewarding Britain's most promising young sailors for their determination, focus and talent. The Marlow award entitles the winner to free Marlow rope for a year, which winners say is invaluable as they launch themselves into the new Olympic cycle.

### OLYMPIC MEDALS 2016:

FINN:	Giles Scott
470	Hannah Mills / Saskia Clark
RS:X	Nick Dempsey
2.4mr MD	Helena Lucas
SKUD18 TP	Niki Birrell / Alexandra Rickham

**GOLD**  
**GOLD**  
**SILVER**  
**BRONZE**  
**BRONZE**

### OLYMPIC MEDALS 2012:

FINN:	Ben Ainslie
2.4mr MD	Helena Lucas
STAR	Iain Percy / Andrew Simpson
470	Hannah Mills / Saskia Clark
470	Stuart Bithell / Luke Patience
RS:X	Nick Dempsey
SKUD18 TP	Niki Birrell / Alexandra Rickham

**GOLD**  
**GOLD**  
**SILVER**  
**SILVER**  
**SILVER**  
**SILVER**  
**BRONZE**



## US SAILING TEAM - OFFICIAL SUPPLIER

Marlow Ropes became the Official Cordage Supplier for the US Sailing Team in 2017 and is committed to working alongside the USST through the 2020 Tokyo Games supporting individual sailors directly as well as working with the team as a whole. Marlow and the US Sailing Team work closely together on rope technology development to ensure the best performing products for the sailors needs.

Marlow is extremely proud to have be associated with a historically successful team and looks to build on this tradition, working with sailors to improve their results and continue the positive growth and success that is expected from the US Sailing Team.

*"Marlow is one of the most trusted names in our sport, and as any sailor knows, having strong, dependable and customized line solutions on board your boat is a key factor in any successful racing program. Our National team loves working with Marlow to provide our sailors and development athletes with the best line products in the world."* Two-time Olympic Champion Malcolm Page (Newport, R.I.), Chief of U.S. Olympic Sailing.

### OLYMPIC MEDALS 2016:

FINN	Caleb Paine
------	-------------

**BRONZE**

## INTER-COLLEGIATE SAILING ASSOCIATION

Marlow Ropes has enjoyed a partnership with ICSA for almost a decade. The ICSA is the governing authority for sailing competition at colleges and universities throughout the United States and in some parts of Canada. There are seven Conferences that schedule and administer regattas within their established geographic regions and Marlow is committed to sponsoring key championships and competitions within the inter-collegiate regatta schedule. The Everett B. Morris Trophy is awarded annually to the Marlow Ropes College Sailor of the Year for outstanding performance at the highest level of sailing in the collegiate year. Marlow Ropes have been title sponsors of this award since 2014. Winners have included:

2014	Graham Landy	Yale University
2015	Nevin Snow	Georgetown University
2016	Nevin Snow	Georgetown University
2017	Ian Barrows	Yale University
2018	Stephano Peschiera	College of Charleston





# RUNNING RIGGING DEFINITIONS

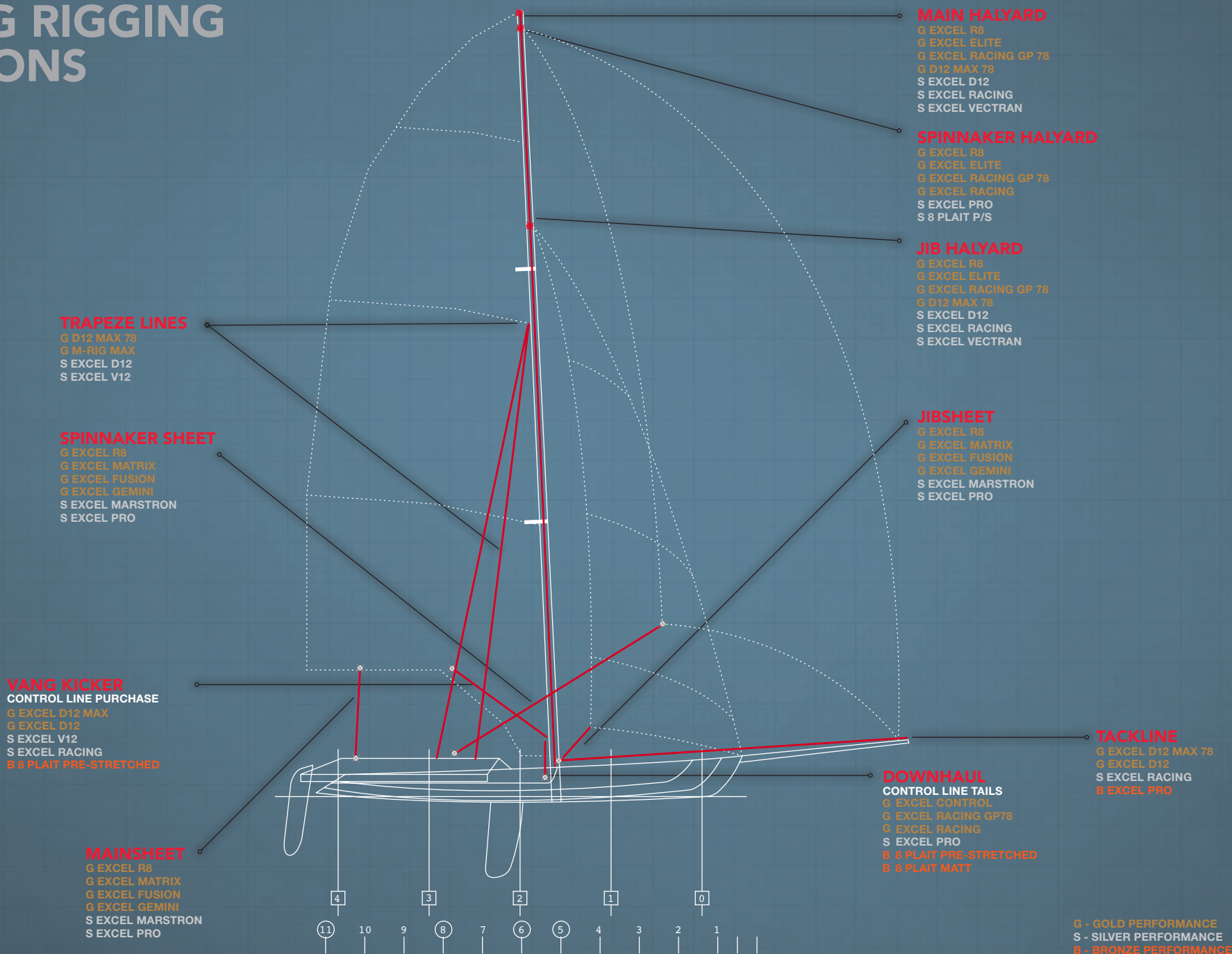



# EXCEL DINGHY SERIES

## EXCEL R8

Technora



APPLICATION :

HALYARDS

SPINNAKER HALYARDS

SHEETS

12 STRAND SK78 CORE | 8 PLAIT TECHNORA® / POLYESTER BLENDED COVER  
DIAMETER: 4mm, 5mm, 7mm, 8mm

This new rope within the Excel range compliments the existing fusion family of products, using a Dyneema® core but with an 8 plait cover blended from Technora® aramid and polyester. Available in 4mm and 5mm diameters where it excels as a halyard working on cleats, and 7mm and 8mm where it works as a high performance sheet performing well in ratchet blocks.

DIAMETER (mm)	4	5	7	8
BREAK LOAD (kg)	893	1200	1620	2550
WEIGHT (kg/100m)	1.08	1.65	2.75	4.45

## EXCEL ELITE

Technora



DIAMETER: 4-6mm

12 STRAND SK99 COLOUR-MATCHED CORE | 16 & 24 PLAIT TECHNORA® / POLYESTER BLENDED COVER

APPLICATION :

HALYARDS

SPINNAKER HALYARDS

DIAMETER (mm)	4	5	6
BREAK LOAD (kg)	1180	1710	2450
WEIGHT (kg/100m)	1.12	1.95	2.72

Why use Excel Elite? Incremental gain. Every advantage, however small adds to overall success. Upgraded Dyneema® SK99 core gives exceptional strength and Technora® blend cover ensures outstanding abrasion and heat resistance. With outstanding performance in cleats, the Technora® blended cover also helps grip with wet hands. Elite is easy to taper, reducing weight and showing off the colour matched ArmourCoat cores.

## EXCEL RACING GP 78

Technora



DIAMETER: 4-6mm

12 STRAND SK78 COLOUR-MATCHED CORE | 16 & 24 PLAIT TECHNORA® / POLYESTER BLENDED COVER

APPLICATION :

HALYARDS

SPINNAKER HALYARDS

CONTROL LINE TAILS

DIAMETER (mm)	4	5	6
BREAK LOAD (kg)	995	1430	2060
WEIGHT (kg/100m)	1.12	1.95	2.72

SK78 core is high strength and minimal creep and the Technora® blended cover gives the same fantastic abrasion and heat resistance properties as Excel Elite. Technora® blend cover adds grip for wet hands, and is easy to taper, showing colour matched ArmourCoat core. Ideal for halyards, sheets and high strength control lines.

## EXCEL RACING



DIAMETER: 1.5-6mm

NEW MOTTLED COVERS NOW AVAILABLE IN:  
BLUE, RED, LIME, ORANGE, SILVER AND BLACK

12 STRAND SK78 COLOUR-MATCHED CORE | 16 &amp; 24 PLAIT POLYESTER COVER

APPLICATION :

HALYARDS

SPINNAKER HALYARDS

CONTROL LINE TAILS

DIAMETER (mm)	1.5	2	3	4	5	6
BREAK LOAD (kg)	139	224	463	995	1430	2060
WEIGHT (kg/100m)	0.17	0.29	0.58	1.24	1.84	2.41

High strength, lightweight with 100% polyester cover and Dyneema® SK78 core for all round use on halyards, sheets and control lines. Easily tapered and holds well in cleats Excel Racing is a great all round rope ideal for stripped halyards and spin sheets due to its easily identifiable solid colour cover and colour matched ArmourCoat core. Great all round performance.

## EXCEL MATRIX



DIAMETER: 6 &amp; 7mm

12 STRAND DYNEEMA® SK78 CORE / 8 PLAIT BLENDED DYNEEMA® & POLYPROPYLENE COVER

APPLICATION :

SHEETS

DIAMETER (mm)	6	7
BREAK LOAD (kg)	1770	1920
WEIGHT (kg/100m)	1.94	2.76

High performance dinghy sheet. Does not kink or absorb water and is easy to taper thanks to thicker Dyneema® core and thinner cover. High grip, blended cover of Dyneema® and Polypropylene means great performance through ratchets and cleats with high resistance to abrasion.

“

The extra grip really helps during the loaded part of the hoist and drop. The wear has been great, it looks almost as new as the first day we put it on the boat. All in all it's brilliant, really nice job!

Dylan Fletcher & Stuart Bithell  
Team 49er, British Sailing Team



## EXCEL FUSION



DIAMETER: 6-10mm

DYNEEMA® SK78 CORE | BLENDED DYNEEMA® &amp; POLYPROPYLENE COVER

APPLICATION :

SHEETS

DIAMETER (mm)	6	7	8	10
BREAK LOAD (kg)	1090	1330	1410	2470
WEIGHT (kg/100m)	1.7	2.2	3	4.4

Super light sheet is soft, flexible and does not absorb water. The blended Dyneema® and Polypropylene cover provides great abrasion resistance through ratchets and cleats. The Dyneema® core means that you experience no stretch and fantastic control through Fusion sheets.

## EXCEL GEMINI



DIAMETER: 7-9mm

TWIN DYNEEMA® SK78 CORES | BLENDED DYNEEMA® &amp; POLYPROPYLENE COVER

APPLICATION :

SHEETS

DIAMETER (mm)	7	9
BREAK LOAD (kg)	995	1430
WEIGHT (kg/100m)	2.31	3.43

All the advantages of Excel Fusion, but with the added bonus of a dual-core system for boats requiring split bridle sheets. The dual core is designed to ensure equal strength and stretch, but removes the need for splicing extra rope to make a second tail.



A percentage of the sales of our PINK ropes will be donated to Cancer Research UK.



# SPERRY

*Since 1935*

agesailing.org

SPERRY  
TOP-SIDER

FJ

QUANTUM SALES

Marlow



# EXCEL DINGHY SERIES

## EXCEL D12



DIAMETER: 2.5-7mm

12 STRAND DYNEEMA® SK78 - ALSO AVAILABLE IN SK99 FOR HIGHER STRENGTH

APPLICATION : **CONTROL LINE PURCHASE** **HALYARDS**

SK78:

DIAMETER (mm)	2.5	3	4	5	6	7
BREAK LOAD (kg)	569	995	2060	2360	3490	5360
WEIGHT (kg/100m)	0.37	0.53	0.98	1.28	1.77	2.80

SK99:

DIAMETER (mm)	2.5	3	4	5	6	7
BREAK LOAD (kg)	677	1180	2450	2800	4150	6380
WEIGHT (kg/100m)	0.37	0.53	0.98	1.28	1.77	2.80

High Strength lightweight option with no water uptake for halyards secured on a rack or hook. Ideal wire replacement offering low friction around blocks. Available in multiple colours for easy line identification and easily spliced thanks to 12 strand single braid construction. Great for adjustable trapeze lines, vang and purchase systems.

## EXCEL CONTROL



DIAMETER: 4-5mm

BRAIDED POLYPROPYLENE CORE | POLYESTER & TECHNORA® COVER

APPLICATION : **CONTROL LINE TAILS**

DIAMETER (mm)	4	5
BREAK LOAD (kg)	478	765
WEIGHT (kg/100m)	1.02	1.59

The first dedicated line for continuous loop control lines. Special snake skin pattern means end-to-end, endless loop splicing with no diameter increase is much easier. Technora cover provides grip as well as heat and abrasion resistance. Distinctive colours aid easy identification. Use our wire splicing needle for best results (p47).

## EXCEL PRO



DIAMETER: 2-6mm

TWISTED POLYESTER CORE | 16 PLAIT POLYESTER COVER

APPLICATION : **SPINNAKER HALYARDS** **SHEETS** **CONTROL LINE TAILS**

DIAMETER (mm)	2	3	4	5	6
BREAK LOAD (kg)	110	202	377	702	986
WEIGHT (kg/100m)	0.27	0.6	1.07	2.15	2.68

Ideal for club racing and cruising. Low stretch, 100% polyester rope offers great performance at a lower cost. Brightly coloured cover for easy identification, which runs well through sheaths and blocks and sheaves. Good range of colours for all control lines on-board.

## EXCEL D12 MAX 78



DIAMETER: 2.5-7mm

12 STRAND DYNEEMA® SK78 - ALSO AVAILABLE IN SK99 FOR HIGHER STRENGTH

APPLICATION : **HALYARDS** **CNTRL LINE PURCH** **STND. RIGG & TRAP. LINES**

DIAMETER (mm)	2.5	3	5	7
BREAK LOAD (kg)	1010	1510	3200	7510
WEIGHT (kg/100m)	0.45	0.68	1.56	3.56

Super light with no water uptake. The 'Max' process adds strength and removes stretch. SK78 and SK99 have virtually no creep, so Excel D12 Max is a great light weight fibre option for standing rigging, removing weight from the rig. Almost zero creep and elongation at working loads. UV resistant.

## EXCEL V12



DIAMETER: 2.5-6mm

12 STRAND VECTRAN® | ARMOURCOAT

APPLICATION : **HALYARDS** **SPINNAKER HALYARDS** **CONTROL LINE TAILS**

DIAMETER (mm)	2.5	3	4	5	6
BREAK LOAD (kg)	627	993	1680	2410	3350
WEIGHT (kg/100m)	0.45	0.67	1.34	1.79	2.24

Easily spliced with zero creep ideal for lines under high load for extended periods.

## EXCEL TAPER



DIAMETER: 6 & 9mm

MATT POLYESTER COVER | EXCEL RACING WITH DYNEEMA® SK78 CORE

APPLICATION : **CONTROL LINE TAILS**

DIAMETER (mm)	6	9
BREAK LOAD (kg)	995	2060
WEIGHT (kg/100m)	2.92	4.59

Ideal for tapered symmetric sheets, Excel Taper uses Excel Racing as its core and is covered with a soft matt polyester braid. The soft cover bulks up thinner Excel racing for those who want light high strength sheets, but prefer a thicker rope to hold on to. Easy on the hands and easily tapered thanks to the special construction cover and the 12 strand core of Excel Racing.

### KEY

- HIGH STRENGTH
- LOW WATER ABSORPTION
- LIGHT WEIGHT
- HIGH FLEX/SOFT HANDLING
- LOW STRETCH
- HIGH ABRASION RESISTANCE





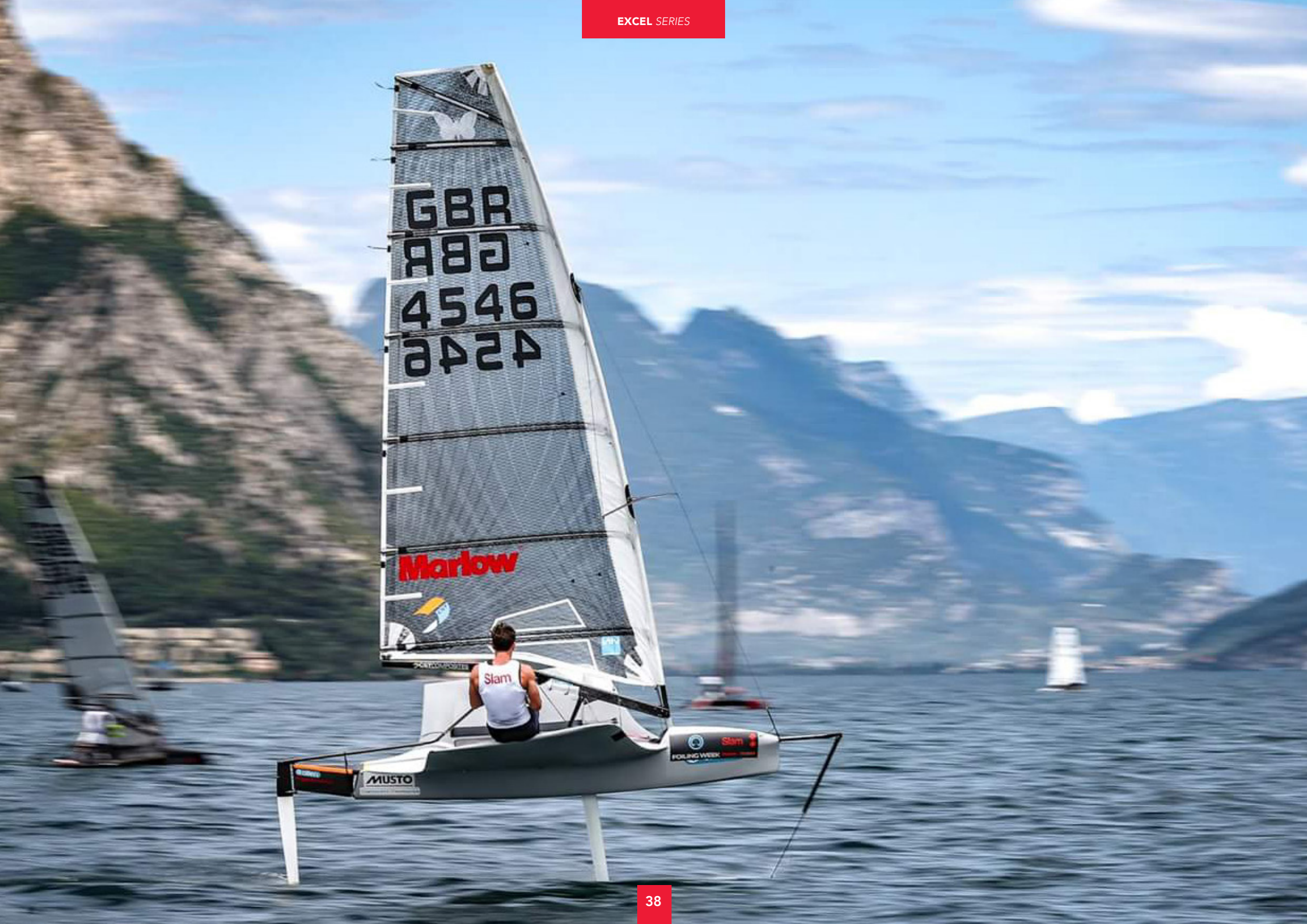



# EXCEL DINGHY SERIES

## EXCEL VECTRAN



DIAMETER: 1.5 - 4mm  
VECTRAN® CORE | 16 PLAIT POLYESTER COVER

APPLICATION : **HALYARDS**

DIAMETER (mm)	1.5	2	3	4
BREAK LOAD (kg)	119	257	329	717
WEIGHT (kg/100m)	0.19	0.32	0.67	1.17

Vectran® cored version of Excel Racing offers zero creep. Great for high load applications where zero elongation is required.

## EXCEL MARSTRON



DIAMETER: 6-8mm  
16 PLAIT POLYPROPYLENE COVER | POLYPROPYLENE CORE

APPLICATION : **SHEETS** **CONTROL LINE TAILS**

DIAMETER (mm)	6	8
BREAK LOAD (kg)	610	941
WEIGHT (kg/100m)	2.3	3.1

This lightweight sheet has super low water absorption and floats – excellent cruising spinnaker sheet.

## 8 PLAIT PRE-STRETCHED



DIAMETER: 4-8mm  
TWISTED POLYESTER CORE | 8 PLAIT POLYESTER COVER | PRE-STRETCHED

APPLICATION : **SPINN. HALYARDS** **CNTRL LINE PURCH** **CNTRL LINE TAILS**

DIAMETER (mm)	4	5	6	8
BREAK LOAD (kg)	428	617	891	1410
WEIGHT (kg/100m)	1.3	2.1	2.9	5.5

Tried and tested option for cruising halyards and control lines. Knobbly 8 Plait construction provides good grip in the hands and in cleats and is great rope for control lines where grip and low stretch are needed. Great abrasion resistance makes this a firm favorite for many years.

## EXCEL MARSTRON+

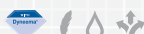

DIAMETER: 6-8mm  
16 PLAIT DYNEEMA® & POLYPROPYLENE COVER | POLYPROPYLENE CORE

APPLICATION : **SHEETS** **CONTROL LINE TAILS**

DIAMETER (mm)	6	7	8
BREAK LOAD (kg)	650	1030	1090
WEIGHT (kg/100m)	1.81	2.12	2.85

The lightest weight sheet has low water absorption and floats. A lightly blended element of Dyneema® in the cover improves abrasion resistance.

## PS12



DIAMETER: 4-6mm  
12 STRAND PRE-STRETCHED POLYESTER

APPLICATION : **CONTROL LINE TAILS**

DIAMETER (mm)	4	5	6
BREAK LOAD (kg)	678	1060	1330
WEIGHT (kg/100m)	1.19	1.91	2.47

12 strand polyester can easily be spliced for halyard tails and lazy jacks.

## 8 PLAIT MATT



DIAMETER: 4-10mm  
TWISTED POLYESTER CORE | 8 PLAIT MATT POLYESTER

APPLICATION : **SHEETS** **CONTROL LINE TAILS**

DIAMETER (mm)	4	5	6	8	10
BREAK LOAD (kg)	293	415	550	889	1440
WEIGHT (kg/100m)	1.3	2.	2.5	4.0	6.0

Soft matt cover makes this a great control line for those who prefer more grip and a softer feel.

## SHOCKCORD



DIAMETER: 3-10mm  
POLYESTER COVER | RUBBER CORES

First quality, high elasticity, natural rubber provides a minimum 100% stretch with constant elongation characteristics. Polyester cover is tough and UV resistant offering good abrasion resistance and a great range of standard colours.

## SHOCKCORD WITH DYNEEMA®



DIAMETER: 4-6mm  
DYNEEMA® COVER | RUBBER CORES

Offers all the benefits of the standard shockcord, however the Dyneema® cover offers greater durability with increased abrasion resistance and lower friction.

## KEY

- HIGH STRENGTH
- LOW STRETCH
- LOW WATER ABSORPTION
- LIGHT WEIGHT
- HIGH ABRASION RESISTANCE
- HIGH FLEX/SOFT HANDLING



# EXTREME SPORTS SERIES

Pioneers in extreme sports, Marlow's 8 Plait Pre-stretched has been a staple for windsurf down hauls and out hauls for years thanks to it's low stretch and tough abrasion resistant cover.

Marlow developed and introduced Formuline, the first 100% Dyneema® rope specifically designed for new high purchase down haul systems. Imitated by many, Formuline remains

the original and best and is now paired with Formula-X for ratchet down haul systems.

Our windsurf lines are complemented by kite lines for both race and freestyle riding as well as Excel D12 which is ideal for leaders, chicken loops and pigtails.

# EXTREME SPORTS

## FORMULINE



DIAMETER: 3.8-4.5mm  
 12 STRAND TIGHTLY BRAIDED DYNEEMA® SK78  
 APPLICATION : OUTHAULS | DOWN HAULS | DE-POWER

DIAMETER (mm)	3.8	4.5	4.8
BREAK LOAD (kg)	619	700	700
WEIGHT (kg/100m)	0.89	1.20	1.69

The first and still the best line specifically designed for use on windsurf down hauls and out hauls. High strength and great durability, Formuline is the perfect diameter to fit most rigs and won't let you down.

## FORMULA-X



DIAMETER: 3.8mm  
 6 PLAID DYNEEMA® SK78  
 APPLICATION : WINDSURFER RATCHET DOWN HAULS | DE-POWER

DIAMETER (mm)	3.8
BREAK LOAD (kg)	619
WEIGHT (kg/100m)	0.89

Formula-X was developed for windsurf down haul ratchet systems. Textured surface grips in ratchets perfectly.

## KITELINE RACE



DIAMETER: 1.3mm & 1.5mm  
 12 STRAND DYNEEMA® SK99

APPLICATION : KITELINES

DIAMETER (mm)	1.3	1.5
BREAK LOAD (kg)	270	360
WEIGHT (kg/100m)	0.14	0.18

Kiteline Race offers great durability and strength even when lines are crossed.

## KITELINE FREESTYLE



DIAMETER: 1.8mm  
 12 STRAND DYNEEMA® SK78

APPLICATION : KITELINES

DIAMETER (mm)	1.8
BREAK LOAD (kg)	455
WEIGHT (kg/100m)	0.24

Larger diameter adds safety factor for extreme freestyle and wave riding. Improved durability when lines are crossed. Low stretch line removes any need for further adjustment with new lines.



**KITELINE RETAIL DISPLAYS NOW AVAILABLE!**

SEE PAGE 49 FOR FURTHER DETAILS

## EXCEL D12



DIAMETER: 2.5-7mm

12 STRAND DYNEEMA® SK78 - ALSO AVAILABLE IN SK99 FOR HIGHER STRENGTH

APPLICATION : PIG-TAILS | DE-POWER | LEADERS | BRIDLE

### SK78:

DIAMETER (mm)	2.5	3	3.5	4	5	6	7
BREAK LOAD (kg)	569	995	1430	2060	2360	3490	5360
WEIGHT (kg/100m)	0.37	0.53	0.74	0.98	1.28	1.77	2.80

### SK99:

DIAMETER (mm)	2.5	3	3.5	4	5	6	7
BREAK LOAD (kg)	677	1180	1710	2450	2800	4150	6380
WEIGHT (kg/100m)	0.37	0.53	0.74	0.98	1.28	1.77	2.80

Lightweight, high-strength Excel D12 can be used by windsurfers as auxiliary lines and lightweight harness lines and by kitesurfers for leader lines and depower lines

## 8 PLAID PRE-STRETCHED



DIAMETER: 4-8mm  
 TWISTED POLYESTER CORE | 8 PLAID POLYESTER COVER | PRE-STRETCHED

APPLICATION : OUTHAULS | DOWN HAULS | LEADERS

DIAMETER (mm)	4	5	6	8
BREAK LOAD (kg)	428	617	891	1410
WEIGHT (kg/100m)	1.3	2.1	2.9	5.5

Polyester option for windsurf down hauls and out hauls, grips well in cleats and provides good abrasion resistance.

### KEY

- HIGH STRENGTH
- LIGHT WEIGHT
- LOW STRETCH
- HIGH ABRASION RESISTANCE
- LOW WATER ABSORPTION
- HIGH FLEX/SOFT HANDLING



# MOORING

Whilst mooring lines are often overlooked, they are equally as important as sheets and halyards – what is the value of the yacht they are securing to the dock?

Marlow manufacture a range of mooring lines to suit every craft, from our Superyacht Mooring lines detailed on Page 21, to our braided docklines and

traditional 3 strand ropes. All have their own particular characteristics, but all are designed not only to ensure the security of a moored vessel, but also to enhance the dockside appearance.

Marlow Docklines are also available pre-spliced in standard lengths.



### CUSTOM DOCKLINES

Fore and Aft Spring lines stop forwards and backwards movement of the boat on its mooring.

**SPRING LINES LENGTH = 3/4 X OVER ALL BOAT LENGTH**

Stern lines stop the stern of the boat moving out, away from the dock

**STERN LINE LENGTHS = 1 1/2 TO 2 X BEAM OF THE BOAT**

Bow Lines stop the bow of the boat moving out, away from the dock

**BOW LINE LENGTHS = 1 1/2 X BEAM OF THE BOAT**

Always inspect your lines regularly for signs of wear. Polyester has good shock absorbing characteristics but areas vulnerable to chafe should be protected with a piece of rubber hose or leather.

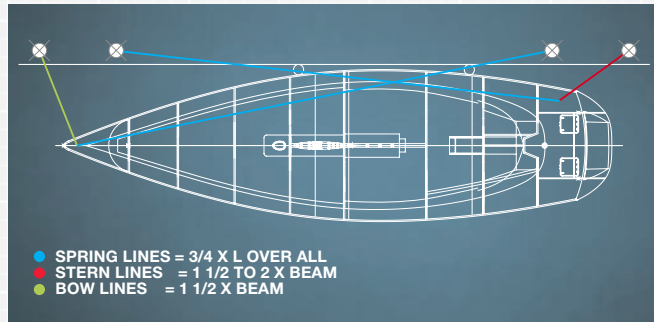

### ANCHOR LINES

Aim to use chain between the Anchor and the Line. This will help gain a good catenary angle and help dig it in, reducing the effect of pitching and tugging and protecting the line from the seabed and abrasion.

Remember when selecting the size of line for an anchor warp, nylon is ideal at absorbing shock loads but it will have some strength reduction when wet.

Have enough line on board to provide scope for at least 7 x the max depth of water expected. In heavy weather when the boat is pitching and tugging, 10 x the depth of water may be needed.

### KEY

- HIGH STRENGTH
- LIGHT WEIGHT
- LOW STRETCH
- HIGH ABRASION RESISTANCE
- LOW WATER ABSORPTION
- HIGH FLEX/SOFT HANDLING

### MARINA GRANDE DOCKLINE



DIAMETER: 18-20mm  
 12 STRAND POLYESTER CORE | 24 PLAIT OPTI-TWIST COVER  
 APPLICATION : **MOORING**

DIAMETER (mm)	18	20
BREAK LOAD (kg)	8835	9920
WEIGHT (kg/100m)	23.4	26.8

The All New Marina Grande has been engineered using our Opti-Twist yarn process as found in our Superyacht Mooring Lines. Opti-Twist provides outstanding abrasion and shock absorbing properties whilst being comfortable to handle and remaining supple, even after long exposure to water and the elements. This 100% polyester mooring rope will not suffer from shrinkage, strength loss or UV degradation like nylon ropes.

### DOCKLINE



DIAMETER: 12-20mm  
 12 STRAND POLYESTER CORE | 24 PLAIT POLYESTER COVER  
 APPLICATION : **MOORING**

DIAMETER (mm)	12	14	16	18	20
BREAK LOAD (kg)	3420	5060	7250	8010	9490
WEIGHT (kg/100m)	9.9	14.2	16.8	22.0	24.0

Extremely soft on the hands, Dockline now has a polyester core and cover, meaning issues from shrinkage and strength loss are eliminated. Thanks to its construction, Dockline is easy to splice, exhibits good shock absorbing properties and remains soft and flexible at all times.



### BLUE OCEAN DOCKLINE

MADE FROM 100% RECYCLED PLASTIC



DIAMETER: 12-16mm  
 12 STRAND rPET CORE | 24 PLAIT rPET COVER  
 COLOUR: BLACK  
 APPLICATION : **MOORING**

DIAMETER (mm)	12	14	16
BREAK LOAD (kg)	3610	4510	5860
WEIGHT (kg/100m)	9.94	12.4	16.2

The **BLUE OCEAN DOCKLINE** made from 100% recycled plastic bottles is exclusive to Marlow's Mooring Series this year. Made from rPET (recycled polyester yarn) this eco-conscious dockline is available pre-spliced in 12-16mm diameters in lengths from 6m to 12m.

The unique construction offers the same popular attributes available with Marlow's other mooring products including good abrasion resistance and shock absorption with soft and supple flexibility and zero strength loss or shrinkage.

*Packaged in environmentally friendly FSC cardboard cartons.*

For further information about Marlow's **BLUE OCEAN** initiatives visit [marlowropes.com](http://marlowropes.com)

### PRE SPLICED DOCKLINES



DIAMETER: 12-20mm  
 MARLOW DOCKLINE WITH 50CM FACTORY SPLICED EYE. WHIPPED OTHER END  
 APPLICATION : **MOORING**

DIAMETER (mm)	12	12	14	14	16	16	16
LENGTH (m)	6	8	8	10	10	12	15

Our factory-spliced docklines have a 50cm spliced eye protected with polyester tubular webbing. Whipped at the other end and supplied in a neat reusable bag, Pre-spliced Docklines are available in a range of standard lengths and diameters.

**7.5** WASTE PLASTIC BOTTLES ARE IN EVERY METRE OF BLUE OCEAN DOCKLINE  
\*BASED ON 10MM DIAMETER







### 3 STRAND PRE-STRETCHED



DIAMETER: 3-12mm  
3 STRAND POLYESTER | PRE-STRETCHED

APPLICATION : **MOORING** **HALYARDS**

DIAMETER (mm)	3	4	5	6	8	10	12	14
BREAK LOAD (kg)	319	583	1030	1690	2180	2640	3340	4840
WEIGHT (kg/100m)	0.98	1.61	2.07	3.06	4.81	8.23	10.7	14.8

Strong, tough and low stretch, 3 Strand Pre-stretched is easily spliced to wire and is a great traditional halyard. In addition, it's hardwearing construction makes it a great low stretch, tough all-round rope.

### 3 STRAND POLYESTER



DIAMETER: 4-32mm  
3 STRAND POLYESTER

APPLICATION : **MOORING**

DIAMETER (mm)	4	6	8	10	12	14	16	18
BREAK LOAD (kg)	529	951	1465	2570	3170	3930	4766	6600
WEIGHT (kg/100m)	1.21	2.73	4.80	7.85	10.9	14.9	19.4	24.6

	20	24	28	32
BREAK LOAD (kg)	9230	11210	14640	18840
WEIGHT (kg/100m)	30.3	46.0	62.8	82.0

The classic mooring line, Marlow's 3 Strand is manufactured using the highest quality materials to produce a rope with perfect flexibility and firmness. Polyester won't degrade in UV and remains supple and strong even when wet.

### MULTIPLAIT NYLON



DIAMETER: 12-32mm  
8 STRAND NYLON

APPLICATION : **MOORING**

DIAMETER (mm)	12	14	16	18	20	24	28	32
BREAK LOAD (kg)	3800	4670	6640	7270	9890	14370	18550	23930
WEIGHT (kg/100m)	9.40	12.9	16.6	21.0	26.0	37.3	51.0	66.4

The classic anchor line, Multiplait has fantastic shock absorbing characteristics when anchoring in rough seas and is easily spliced to chain thanks to its 8 strand construction and special markers. Its soft flexible, unkinkable construction makes it perfect for easy stowage, whilst still maintaining excellent grip on the windlass.

### 3 STRAND BUFF POLYESTER PRE-STRETCHED



DIAMETER: 8-16mm  
3 STRAND MATT POLYESTER

APPLICATION : **MOORING** **HALYARDS**

DIAMETER (mm)	8	10	12	14	16
BREAK LOAD (kg)	1320	1500	2550	3110	3800
WEIGHT (kg/100m)	5.1	6.9	10.6	14.6	16.4

Same great benefits as the standard 3 Strand Pre-stretched, but in a buff colour for a traditional "Natural Fibre" look.

### HARDY HEMP



DIAMETER: 6-24mm  
3 STRAND POLYPROPYLENE

APPLICATION : **MOORING**

DIAMETER (mm)	6	8	10	12	14	16	18	20	24
BREAK LOAD (kg)	390	640	1030	1470	2020	2870	3330	4470	5940
WEIGHT (kg/100m)	1.50	2.80	4.50	6.20	8.10	11.7	14.0	19.4	26.3

Soft handling and a "hairy look and feel" mean this rope has the authentic look of natural fibre. However, being made from polypropylene, Hardy Hemp gives all the aesthetic qualities of natural fibre but with the benefits of modern technology – floats, non-rot, UV resistant.

### 3 STRAND NELSON



DIAMETER: 4-10mm  
3 STRAND POLYPROPYLENE

APPLICATION : **MOORING**

DIAMETER (mm)	6	8	10	12	14	16	18	20	24	28	32
BREAK LOAD (KG)	648	1145	1685	2387	3294	4072	5195	6264	8770	11556	14537
WEIGHT (kg/100m)	1.70	3.00	4.50	6.50	9.00	11.5	14.8	18.0	26.0	35.5	46.0

A tough, no nonsense 3 strand rope manufactured using staple polypropylene fibres. High grip, abrasion resistance and lightweight, Nelson makes a great easily spliced general purpose rope.

### 3 STRAND NYLON



DIAMETER: 6mm - 32mm  
3 STRAND NYLON

APPLICATION : **MOORING**

DIAMETER (mm)	6	8	10	12	14	16	18	20	24	28	32
BREAK LOAD (kg)	860	1540	2400	3560	4850	5520	6900	8630	12400	16900	22080
WEIGHT (kg/100m)	2.30	4.00	6.20	8.90	12.2	15.8	20.0	24.5	35.5	48.5	63.0

Nylon will stretch by about 20% at 50% of its breakload, compared with 12% stretch for polyester at equivalent loads. This high elongation, makes 3-strand nylon a good choice for anchor warps, mooring warps and mooring risers. Care should be taken when choosing 3-strand nylon ropes through, as Nylon is susceptible to external environmental factors such as salt water and UV.

### NOR'EASTER MOORING PENDANT



DIAMETER: 13mm, 18mm, 24mm  
D12 MOORING PENDANT WITH ARMOURCOAT

APPLICATION : **MOORING**

Low stretch and high abrasion resistance exactly where needed - at the choke, virtually eliminating friction generated failure. The Nylon pendant gives high stretch in the standing part of the rope providing shock absorption to protect your hardware. This low stretch configuration combined with superior chafe resistance where needed is ideal for all craft, from runabouts to mega yachts.

DIAMETER (mm)	13	13	18	18	24	24
LENGTH (ft)	6	8	8	12	12	16
BREAK LOAD (kg)	15900	15900	25200	25200	53000	53000
WEIGHT (kg/100m)	8.0	8.0	14.3	14.3	31.8	31.8

### TFH CHAFEGUARD



DIAMETER: 19mm - 70mm  
TUBULAR POLYESTER SLEEVE

APPLICATION : **MOORING**

TUBE WIDTH FOR ROPE DIAMETERS

25mm	8mm, 10mm, 12mm
32mm	14mm, 16mm, 18mm
42mm	24mm, 22mm, 20mm

Rubber lined with tough polyester cover, TFH Chafe Guard is tough, durable and ideal for spliced eye protection or adjustable protection on the rope itself to protect against abrasion from chocks, bits, bollards and cleats.



# ACCESSORIES

## MARLOW'S BEST SELLING GUIDE TO SPLICING

With over 200 years of technical knowledge and rope care expertise, our highly anticipated *Guide to Splicing* is an indispensable instruction manual for all sailors and boat owners. Detailed illustrations and stage by stage instructions will guide even the most novice of sailors through a variety of recommended splices that will ensure their ropes are used to their full potential.

66 page A5 wirebound book with laminated covers and dividers  
ISBN: 978-1-5272-2927-3

"MARLOW KNOWS A THING OR TWO ABOUT ROPES, AND THIS WILL SURELY BECOME THE DEFINITIVE GUIDE FOR BOTH AMATEUR AND PROFESSIONAL SAILORS."

Dame Ellen MacArthur, DBE





# SPLICING TOOLS

## SWEDISH FIDS

Traditional steel splicing fids with a wooden handle, swedish fids are used for Multiplait, 3 strand and Marlowbraid splicing (in conjunction with the riggers splicing needle).



## SAILMAKERS NEEDLES

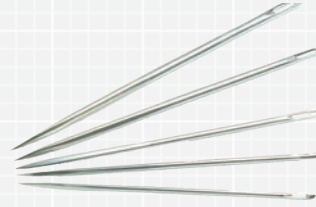

High quality, traditional sailmakers needles in a mixed pack offering different sizes and shapes.

## YACHTSMAN'S SPLICING ROLL



This tough roll up tool bag includes small and large swedish fids and small and larger riggers splicing needles along with Marlow tape, whipping twine and a marker pen. The splicing roll has additional pockets for the budding splicer to expand their splicing tool collection with braid-on-braid splicing fids, scissors, sailmakers needles and a splicing knife.

## BRAID-ON-BRAID FID SET

The best option for splicing braid-on-braid, this fid set includes 4mm fid up to 12mm fid. Also used for D12 (12 strand) splices and can be used for 3 strand lines also.



## SPLICING KIT

Starter splicing kit includes small and large splicing needles, small swedish fid, whipping twine, Marlow tape and splicing instructions – perfect for the novice.



## SAILMAKERS PALM

Tough leather palm with added protection over the ball of the thumb allowing stitching and whipping of even the toughest ropes.



## EXTRA POWER TEFLON SCISSORS



Tough Teflon® coated scissors especially chosen for their ability to cut Dyneema®. These scissors are used by our factory splicers.

## RIGGERS SPLICING NEEDLES

Splicing needles used for Marlowbraid (quick splice), D2 (covered Dyneema® splice) and can be used on D12 (12 strand Dyneema® splice).



## WHIPPING TWINE NO.2 NO.4 NO.8 NO.16

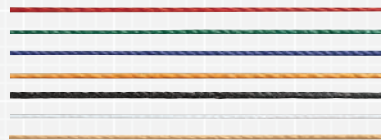

SIZE	No.2 (Thin)	No.4 (Med.)	No.4 (Med.)	No.4 (Med.)	No.4 (Med.)	No.4 (Med.)	No.4 (Med.)	No.4 (Med.)	No.8 (Lge.)
COLOUR	white	white	red	blue	black	green	gold	beige	white
DIAMETER(mm)	0.5	0.8	0.8	0.8	0.8	0.8	0.8	0.8	1.1

Marlow whipping twine is widely regarded as the best whipping twine on the market, the polyester whipping twine is available in 4 sizes and a variety of colours (No.4 only). The waxed finish makes for easier whipping and a better finish. Available in "display boxes" of 12 spools or on 1kg cops.



## MARLOW TAPE

Marlow branded tape for splicing and finishing of ropes.



## EXCEL SPLICING NEEDLE



Multipurpose splicing needle for very small diameter dinghy ropes such as Excel Control, Excel Racing and Excel D12. Also great for tapering Fusion and Matrix.

## MARLINE

Marlow's traditional tarred waterproof hemp twine comes in two sizes – large and small. Use for whipping wire splices, mooring posts, heavy duty static mooring lines etc.





# ACCESSORIES

## SHOCKCORD



DIAMETER: 3-10MM

POLYESTER COVER | RUBBER CORES

Excellent quality, high elasticity, natural rubber provides a minimum 100% stretch with constant elongation characteristics. Polyester cover is tough and UV resistant offering good abrasion resistance and a great range of standard colours.

**SHOCKCORD WITH DYNEEMA®**  DIAMETER: 4-6MM



All the benefits of the standard Shockcord, yet with greater durability, increased abrasion resistance & lower friction due to its Dyneema® cover.

## 8 PLAIT MARSTRON



DIAMETER: 6-10mm

8 PLAIT POLYPROPYLENE COVER | POLYPROPYLENE CORE | 100M & 200M REELS

APPLICATION : **THROW LINES AND PAINTERS**

DIAMETER (mm)	6	8	10
BREAK LOAD (kg)	499	645	1242
WEIGHT (kg/100m)	1.76	2.70	5.0

Lightweight, High Visibility floating line. Soft and easily handled, 8 Plait Marstron is ideal for rescue throw lines, tow ropes and painters.

## 8 PLAIT STANDARD



DIAMETER: 1.5-4mm

8 PLAIT POLYESTER

DIAMETER (mm)	1.5	2	3	4
BREAK LOAD (kg)	90	130	210	359
WEIGHT (kg/100m)	0.25	0.33	0.70	1.16

100% polyester line for flag halyards and burgees. Also used as leach lines, and whipping large diameter ropes as well as decorative lashings.

## GUARD RAIL NETTING

Knotted white nylon netting. Handy Tip – measure the distance the netting needs to run fore and aft and allow an additional 25%. This allows for take up in the length caused by the drop on standard stanchions (61cm / 24").



## WEBBING

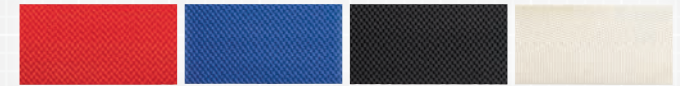

TYPE	MATERIAL	WIDTH	REEL LENGTH	BREAK LOAD	COLOUR
TOE STRAP	Polyester	50mm	50m	1800kg	red / blue / black
BUOYANCY BAG	Polyester	38mm	100m	750kg	white
JACKSTAY	Polyester	25mm	50m	3000	blue

Selection of towstrap, buoyancy bag and jackstay webbing.

## BUOYANCY BAG WEBBING

38mm wide Polyester webbing available in white. Light weight and ideal for lighter webbing duties.

## TOE STRAP WEBBING

50mm wide polyester webbing available in 3 strong colours. Tough, strong and low stretch webbing for Toe Straps on dinghy's and sports boats.

## JACK STAY

Tough 25mm wide polyester webbing offers a 3 tonne break load and is perfect for those heavy duty jobs.

## D12 SOFT SHACKLES

Factory spliced D12 Soft Shackles offer outstanding strength at a fraction of the weight of conventional steel shackles.



DIAMETER (mm)	4	5	6	7	9	11
BREAK LOAD (kg)	2370	2710	4010	6160	7980	13300
WEIGHT (g)	5.5	9.0	14.9	27.4	47.4	89.6
LENGTH (m)	200	250	300	350	450	550

Important note: The lengths listed in the specification are for both the closed circumference and open length. Closed length is approximately half the open length assuming the bearing surfaces are not too big. All these figures are approximate as they are hand made by artisans.



# POINT OF SALE

## CORDLESS HOT KNIFE

VOLTAGE: DC14.4V WEIGHT (INC BATTERY & BLADE): 0.7kgs

Marlow's new cordless hot knife cuts and heat-seals ropes quickly and efficiently with the blade reaching a temperature of 400°C in seconds. Supplied in a handy carry case shown in the image below including 1 x KD-DC100R Handle, 1 x brush, 1 x battery pack 14.4V/2.0Ah



## HAND HELD HOT KNIFE

AVAILABLE IN 240V AND 110V

Marlow hot knife for cutting and heat-sealing ropes in one stroke. Use in conjunction with Marlow Tape for a perfect finish. Supplied in a handy carry case with a metal bristled cleaning brush.



## MINISPOOLS

Excel Racing and Excel Pro available on handy 30m (2mm) and 17m (3mm) spools. Display on euro slot cards or stack on the counter for impulse buy.



## CARDED ACCESSORIES

Retail packaging is now available for a number of our accessories. Suitable to be displayed on euro slots. As part of our racking system.



# RACKING

## POINT OF SALE RACKING



Supplied to Marlow Dealers directly or through distributors, the striking Marlow rope rack sets our products apart from the crowd with its freestanding design and an optional integrated light-box.

The racking includes label fascia which can be customised to the specific ropes displayed on the rack with labels downloadable from the dealer section of our website.

As well as clearly labeling the ropes on the rack, the labels are colour coordinated with both this brochure and our pocket retail guide to help customers choose the correct rope for each application.

## MINI SPOOL DISPENSER RETAIL DISPLAY



Marlow's Mini Spool Dispenser is a great point of sale display for till spaces and table-tops, available **free of charge** when purchased with 15 Excel Pro 2mm & 3mm mini-spool reels (mixed colours).

Spools can be reordered as and when required.

## KITELINE RETAIL DISPLAY

Marlow's KiteLine Retail displays are available **free of charge** when purchased with a minimum of the following:

- 20 KiteLine mini-spools (30m)
- 6 KiteLine splicing needles

Should you wish to purchase larger quantities this is also possible as the displays are able to hold a higher volume of stock than shown.

Spools and needles can be reordered as and when required.





GOING UP THE MAST

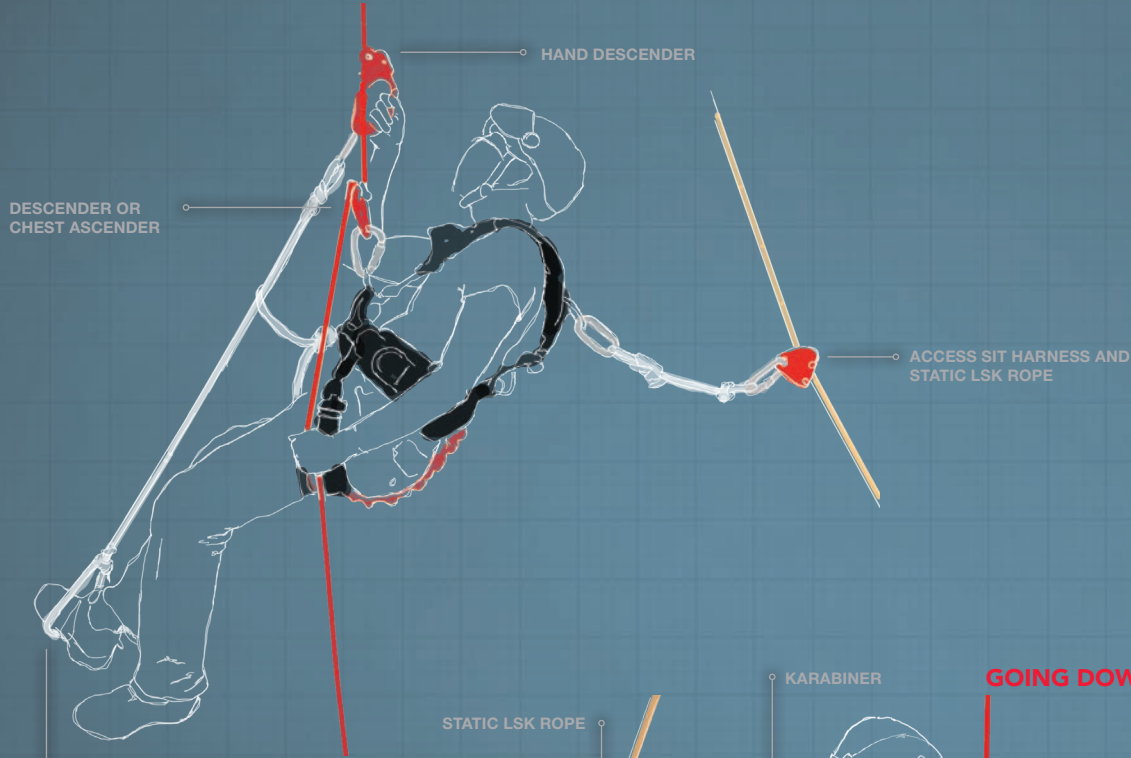

GOING DOWN THE MAST

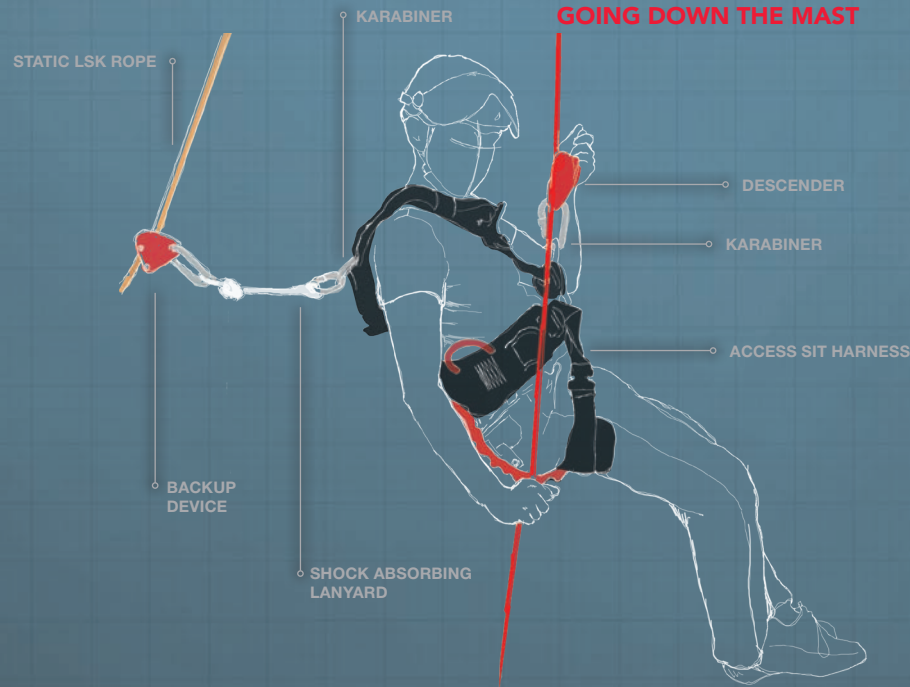

# MAST CLIMBING

## MARLOW SAFETY AT HEIGHT

Climbing the rig to check its integrity or to make repairs can be a dangerous job, so we are glad to be able to use our experience gained in the Professional Rope Access market to provide a comprehensive range of safety at height equipment for yacht riggers.

The equipment listed here includes everything necessary to undertake a safe ascent, effect a comfortable work positioning and return to the deck safely, whether the climber is assisted or working alone. This includes:

## STATIC LSK ROPE

SPECIALIST SAFETY AT HEIGHT ROPE WITH HIGH ELONGATION, AVAILABLE IN VARIOUS COLOURS TO DIFFERENTIATE WORKING ROPE AND BACK-UP ROPE

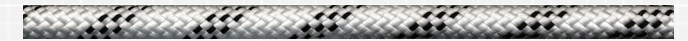

**Construction:** Twisted Polyamide (Nylon) core / 16 plait Polyamide (Nylon) cover

**Colours:** White with black or red flecks. 9mm (cross fleck), 10.5mm (double fleck), 11mm (triple fleck), 12mm (four fleck) 11mm & 12mm available in solid colours also

**Applications:** Abseiling, work positioning, industrial rope access

**Benefits:** AquaCoat water repellent coating on request. Flexibility & suppleness, abrasion resistance. Outstanding dynamic properties, visible year of manufacture marker

DIAMETER (mm)	10.5	11	12
ROPE CLASSIFICATION (TYPE)	A	A	A
MASS (g/m)	67.2	73.8	90.3
50-150KG ELONGATION (%)	2.0	2.4	1.9
FALL FACTOR 1 FALLS (FIG 8 LOOP)	10+	10+	10+
PEAK FORCE FIG 8 LOOP (kN)	5.6	5.8	5.5
AV. STATIC STRENGTH FIG 8 LOOP (kN)	19.5	21.1	24.3
CE STANDARD	EN1891	EN1891	EN1891

Specialist safety at height rope with high elongation, available in various colours to differentiate working rope and back-up rope.

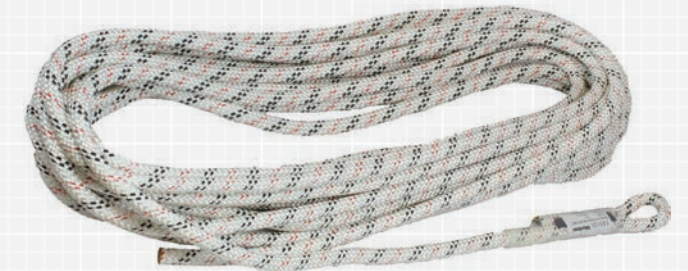

**ACCESS SIT HARNESS**



A sit harness specifically developed for long periods of suspension. The waist belt and leg loops offer broad structural support and are connected by optimally spaced connection straps that give the harness a precise, comfortable fit. Pair it with the updated GT Chest (ref.2166) for a full body fall arrest harness. Lightweight aluminum alloy components with detachable Speedy Alu buckles on the leg loops. 3 full-strength attachment points: 1 front, 2 side. 2 sizes.

**GOBLIN BACK-UP**



The Goblin fall-arrester represents a monumental step forward in safety for workers who rely on fall arrest systems for work at heights. To be used on semi-static ropes ranging from 10 to 11 mm. The innovative cam also creates perfectly smooth action on the rope whether it is being used to ascend or descend the line. Wear and tear on the rope is reduced to the minimum thanks to the specially designed locking mechanism that lowers the fall arrest force.

**GOBLIN LANYARD**



The Goblin Lanyard has been designed to integrate seamlessly with the Goblin by producing the proper distance between the user and the safety line. Available in two lengths: 26 and 40 cm.

**ACCESS CHEST ATTACHMENT**

A step forward in comfort for technical rope access workers. The structure and padding have been shaped for optimal ergonomics, especially on the neck. Double height adjustment (front and back) allows the worker to perfectly fine-tune the fit. Supplied with the patented HMS Belay Lock connector that features an anti-rotation system for a secure attachment to the sit harness. Equipped with tension strap for securing a chest ascender in a streamlined way.



**PILOT HAND ASCENDER (LEFT & RIGHT)**



A handled ascender designed for efficient movement along fixed lines. The cam has 17 teeth for a solid grip on the rope. The aluminium alloy frame is light yet durable and has a long rope channel for better performance on traverses. The ergonomic thermo-molded handle provides good insulation and aids grip when wet. The handle extends down around the bottom hole to provide a wide radius that reduces wear on webbing.

**TURBO FOOT LOOP**



Foot loop for use in rope ascent. Quick adjustment from 95 to 150 cm by means of a steel buckle. Tensioning strap for the foot and a reinforced main attachment point.

**ACCESS SWING ATTACHMENT**



A lightweight, rigid aluminium alloy seat with plush padding for prolonged suspension work. Designed to integrate seamlessly with the Access Sit and Tree Access harnesses using the proprietary Sicura buckles. Equipped with a buckle for connecting to the back of the Access Sit harness when not in use.

**DRUID**



A lightweight compact auto-braking descender for rope access and rescue designed for semi-static ropes ranging from 10 to 11 mm. Proprietary anti-panic function in the lever re-engages the cam if the handle is pulled too far where it could lead to unsafe descent speeds. The cam can be de-activated with a trigger to allow quick sliding of the rope in situations with no load or limited load.

**KARABINERS**

**VARIOUS LIGHTWEIGHT ALLOY KARABINERS USED FOR EQUIPMENT CONNECTION**

**GUIDE 3 LOCK**

Super strong and durable aluminium alloy 'D' shaped connector. Key lock closure avoids snagging. CE marking including individual serial number.



**HMS 3 LOCK**

Aluminium alloy connectors with large opening, ideal for knots. Key lock closure avoids snagging. CE marking including individual serial number.

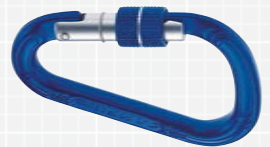

**OVAL 3 LOCK**

Aluminium alloy oval connectors, ideal to be used with descenders and ascenders. Key lock closure avoids snagging. CE marking including individual serial number.

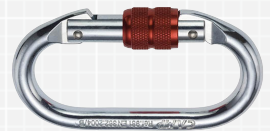

**ARMOUR WORK HELMET**

Safety helmet designed for technical activities. Certified according to EN 12492, it also meets the requirements of energy absorption and resistance to penetration of EN 397. This makes the Armour Work the perfect solution for anyone looking for a lightweight, comfortable, well-ventilated helmet with a full-strength chin strap. ABS shell with high density EPS foam on the inside. Equipped with clips for fastening ear protection and the Armour Work Visor. Available in 4 colors.



MINIMUM ORDER QUANTITIES APPLY. VISIT OUR WEBSITE FOR FURTHER INFORMATION.

WWW.MARLOWROPES.COM



# USEFUL INFORMATION FULL WEIGHT & BREAK COMPARISON TABLE

DIAMETER (mm)	YACHTING																														
	3	4	5	6	7	8	9	10	11	12	13	14	15	16	18	20															
D2 GRAND PRIX 78						3490	3.90			5360	5.92			6940	9.29			9270	11.7			12800	16.6	15900	18.5						
D2 RACING 78						3490	3.90			5360	5.92			6940	9.29			9270	11.7			12800	16.6	15900	18.5						
D12	995	0.53	2060	0.98	2360	1.28	3490	1.77	5360	2.80	6330	3.30	6940	3.76	9270	4.83	11600	5.82	12800	6.5	15900	8.00		18400	9.80						
V2 RACING											3350	4.89			5750	6.65			8680	10.7			11000	13.4		12000	17.1	14700	22.1		
D2 CLUB											2190	4.14			3780	6.98			5200	8.76			7400	12							
DOUBLEBRAID						1390	2.84				2560	4.80			3690	7.47			4760	11.1			6050	15.6		7230	19.3	7910	23.2		
MARLOWBRAID						986	2.68				1580	4.45			2850	7.30			4450	10.0			5460	14.5		7420	19.0	10200	23.5	11300	28.5
MATTBRAID						600	2.80				1120	5.00			1980	7.00			2810	9.90			3300	12.6		5430	17.8				
3 STRAND PRE-STRETCHED	319	0.98	583	1.61	1030	2.07	1690	3.06			2180	4.81			2640	8.23			3340	10.66											
PRODRIVE															2640	5.20		4390	8.10			6560	11.6			7870	15.2			13100	25.0
M-RIG MAX	1350	0.68	2220	1.11	2870	1.56	4110	2.23	6740	3.56	8430	4.45	9690	5.40	11300	6.30	13600	7.55	16200	9.00	19000	10.7			23700	13.4					

DIAMETER (mm)	DINGHY & WINDSURF																							
	1.5	2	2.5	3	4	5	6	7	8	9	10													
EXCEL R8						893	0.72	1200	1.11			1620	1.84	2550	2.98									
EXCEL ELITE						1180	1.12	1710	1.95	2450	2.72													
EXCEL RACING GP 78						995	1.12	1430	1.95	2060	2.72			3490	3.90								5360	5.92
EXCEL RACING	139	0.17	224	0.29		463	0.58	995	1.24	1430	1.84	2060	2.41											
EXCEL MATRIX												1770	1.94	1920	2.76									
EXCEL FUSION											1090	1.7	1330	2.2	1410	3.0	2470	4.4						
EXCEL GEMINI											995	2.31				1430	3.43							
EXCEL D12					569	0.37	995	0.53	2060	0.98	2360	1.28	3490	1.77										
EXCEL D12 MAX 78					1010	0.45	1510	0.68	2480	1.10	3200	1.56	4570	2.23	7510	3.56								
EXCEL V12					627	0.45	993	0.67	1680	1.34	2410	1.79	3350	2.24										
EXCEL PRO																								
EXCEL CONTROL				110	0.27																			
EXCEL TAPER																								
EXCEL VECTRAN																								
EXCEL MARSTRON +	119	0.19	257	0.32																				
EXCEL MARSTRON																								
8 PLAIT PRE-STRETCHED																								
8 PLAIT MATT																								
PS12																								

DIAMETER(mm)	EXTREME SPORTS				
	1.3	1.5	1.8	3.8	4.5
FORMULINE					
FORMULA-X					
KITELINE RACE	270	0.14	360	0.18	
KITELINE FREESTYLE					

DIAMETER (mm)	ACCESSORIES				
	4	5	6	8	10
8 PLAIT MARSTRON					

DIAMETER (mm)	ACCESSORIES							
	1.5	2	3	4				
8 PLAIT STANDARD	90	0.25	130	0.33	210	0.70	359	1.16

DIAMETER (mm)	MOORING & ANCHORING																							
	4	6	8	10	12	14	16	18	20	24	28	32												
MARINA GRANDE																								
DOCKLINE																								
3 STRAND POLYESTER	529	1.21	951	2.73	1465	4.80	2570	7.85	3170	10.9	3930	14.9	4766	19.4	6600	24.60	9230	30.3	11210	46.0	14640	62.8	18840	82.0
MULTIPLAIT NYLON																								
3 STRAND BUFF POLYESTER PRE-STRETCHED																								
HARDY HEMP																								
3 STRAND NELSON																								

**KEY:** Average break Load (kg) Mass (Kg/100m)

# LINE SELECTION GUIDE

The guide below, details diameters per application for the average cruiser/racer based on polyester ropes such as Marlowbraided or Doublebraided.

From a performance perspective strength and stretch are most important and the higher strength to weight ratio of ropes with Dyneema means that at least one size smaller can be used e.g. An 8mm or 10mm D2 Racing can be used instead of 12mm Marlowbraided.

However, when choosing any line, it is important to achieve a balance between performance and the ability to handle the line effectively – if the rope is too thin, the crew may find it more difficult to hold on to and your existing deck gear may struggle to work with it.

## OVERALL YACHT LENGTH (M)

6-8m 9m 10m 11m 12m 14m 16m 18m

### SAIL AREA sq.m (approx)

MAIN	8.5	13.5	16	18.5	23.5	37.5	50	67
GENOA/JIB	9	16.5	25	33.5	42	58.5	71	83.5
SPINNAKER	37.5	46	54.5	71	92	117	150.5	184

### SHEET SIZE diameter (mm)

MAIN	8	10	10	10	12	12	14	16
GENOA/JIB	8	10	10	12	12	14	16	18
SPINNAKER	8	8	8	10	10	12	14	16
SPINNAKER/GUY	8	8	10	10	12	14	16	18

### HALYARD SIZE diameter (mm)

MAIN	10	10	12	12	14	14	18	20
GENOA/JIB	10	10	12	12	14	14	18	20
SPINNAKER	8	8	10	10	12	12	14	16

USE ONE SIZE DOWN FROM THE SIZES DETAILED IN THIS CHART WHEN SPECIFYING ROPES WITH DYNEEMA® CORES

## MOORING ROPES

6-8m 9m 10m 11m 12m 14m 16m 18m

DISPLACEMENT TONNES	2	4	5	6.5	8	11	12	20
POLYESTER LINE (MM)	8-10	12	12	14	14	16	18	24

## ANCHOR WARPS, PAINTER LINES

6-8m 9m 10m 11m 12m 14m 16m 18m

DISPLACEMENT TONNES	2	4	5	6.5	8	11	12	20
NYLON LINE (MM)	12	14	16	16	18	20	20	24





# ROPE CARE & STORAGE

Marlow products are an investment and should be looked after accordingly. They are designed and manufactured to an exceedingly high standard and Marlow know how each can be expected to perform and last under varying conditions. The guidelines listed will help you maintain your ropes in terms of their durability, performance, and reliability.

## GENERAL GOOD PRACTICE:

- Inspection all ropes regularly to establish their condition.
- Ensure the ropes suitability for its intended use.

## CHECK FOR:

- Chaffing or seriously worn surface areas
- Kinks/twists in the rope
- Movement in splices and joins
- Broken, cut or frayed strands
- Compacted or hardened areas
- Surface friction burns or melted sections
- Chemical exposure and degradation
- UV degradation

Should you be in any doubt about the true condition of the rope and its suitability for continued use, consult your nearest Marlow approved rigging specialist.

## OTHER INFORMATION

### ROPE STRENGTHS AND WEIGHTS

Rope strengths are tested according to Marlow's QA25 and 26 quality procedures. Generally these procedures are in line with BS EN ISO 2307, however, a number of other internationally recognised test standards are used including EN 1891, EN 892 and EN 564.

Rope mass is determined by weighing a sample of rope whose length has been measured at a reference load. For most ropes this load is calculated as:

$$\text{Reference Load (kg)} = \frac{d^2}{8}$$

Where d is the rope nominal diameter (mm)

Most rope strengths in this catalogue are given in kilograms (kg). However, the correct measure of force or breaking strength is Kilonewtons (kN). Conversion factors from one to the other are:

**Kg to kN x 0.00981**

**kN to kg x 101.972**

**Kg to lb x Kg x 2.2**

### SHEAVES, PULLEYS AND ROLLERS

When any rope is used around a sheave there will be a reduction in its strength and life. For most non-specialised applications a sheave diameter 8-10 times the rope diameter will suffice, however certain materials such as Aramids may require a sheave size of up to 20 times diameter.

The profile of the groove in a sheave should support the entire rope. Normally a semicircle of 10% greater diameter than that of the rope is appropriate. 'V' groove sheaves should be avoided since they compress the rope and have points of local friction reducing the life of the rope.

## IN ADDITION:

- The coiling and uncoiling of a rope is the first step to ensure that your rope is not damaged - never allow the rope to become kinked or twisted as this will impair its life and usability. Ideally rope should be stored in a 'Figure of 8' fashion to avoid inducing twist.
- Sharp bends put strain on rope as this reduces the number of rope fibres taking the load. The remaining fibres can be rendered ineffective through compression.
- Ropes wear excessively through chaffing and abrasion if they are worked in the same position for any length of time. Inspect the ropes load bearing areas or 'hot spots' and alter their position on a regular basis. Load bearing 'hot spots' include; Halyard Sheaves, Turning Blocks, Cleats, Fairleads, Genoa Cars, Ratchets, Stoppers and Swivels.
- The ideal rope diameter for each Sheave is available from your Marlow approved rigging specialist or can be found in the guide on page 42.
- Friction will cause strands to melt both externally and internally. But as the melting point of most rope fibres is between 150' - 260'C the risk of damage in normal cruiser / racer situations is slight. If a rope has been overloaded, open the strands to check for heat damage (fusion of strands).
- A correctly spliced rope has between 90 - 95% of the strength of the unspliced rope. Regular inspection of splices is important, if you are unsure

about their condition consult your nearest Marlow approved rigging specialist. The break loads in this brochure are for spliced ropes.

## STORAGE AND SEASON END:

- Ropes should be stored under a suitable cover and not left to withstand the elements at the end of the season
- They should be clean and dry, out of direct sunlight and away from extreme temperatures.
- Never store ropes on concrete or dirty floors, as dirt and grit picked up by the ropes can work into the strands cutting the inside fibres, leading to damaged ropes and equipment.
- Keep away from all chemicals.
- Salt crystals are naturally abrasive and will affect the life and efficiency of ropes; a wise precaution would be to soak them in fresh warm water.
- Ropes can be washed in a washing machine on a gentle cycle with mild detergent.

If inspected regularly and maintained correctly there is no reason why Marlow ropes cannot last for many seasons of trouble free sailing.

## WINCHES AND CAPSTANS

When a rope is wound onto a winch it is important that the wraps are neat and tightly wound. This can be achieved by winding the rope on whilst under tension. If the rope is wound on slack then it will be more prone to burying between the turns of the previous layer.

Length of rope that can be held on a winch drum or reel can be calculated as follows:

$$\text{LENGTH (m)} = \frac{710000 \times T (F^2 - D^2)}{d^2}$$

## WHERE:

- T= Traverse in metres
- F= Flange diameter in metres
- D= Drum diameter in metres
- d= Rope diameter in millimetres

## TERMINATIONS

**SPLICES:** Most Marlow ropes can be spliced, this is normally the preferred method of termination. A good splice using the recommended method should not reduce the strength of a rope by more than 10%.

**KNOTS:** A knot will reduce the strength of the rope, sometimes very significantly. This loss is caused by the tight bends and compression found in any knot. The amount a rope will be weakened will depend on the knot, type of rope and the material from which it is made but can be up to 60%.

**EYE SIZES:** Wherever possible the angle formed at the throat of a splice when it is loaded should be 30 degrees or less. This means that the length of the eye when flat must be at least 2.7 times the diameter of the object over which the eye is to be used and the distance from the bearing point to the throat when in use should be at least 2.4 times the diameter.

Some materials like Aramids and HMPEs will require a larger eye with an angle at the throat of 15 degrees or less.

## LOAD-EXTENSION CHARACTERISTICS

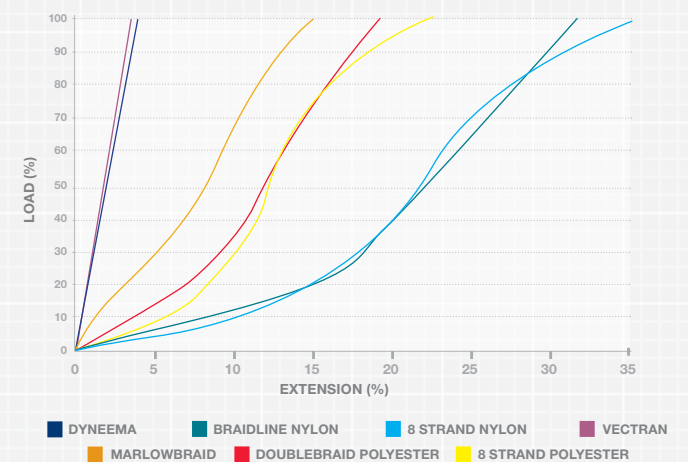

# RETAINED STRENGTH

## SPLICED ROPE

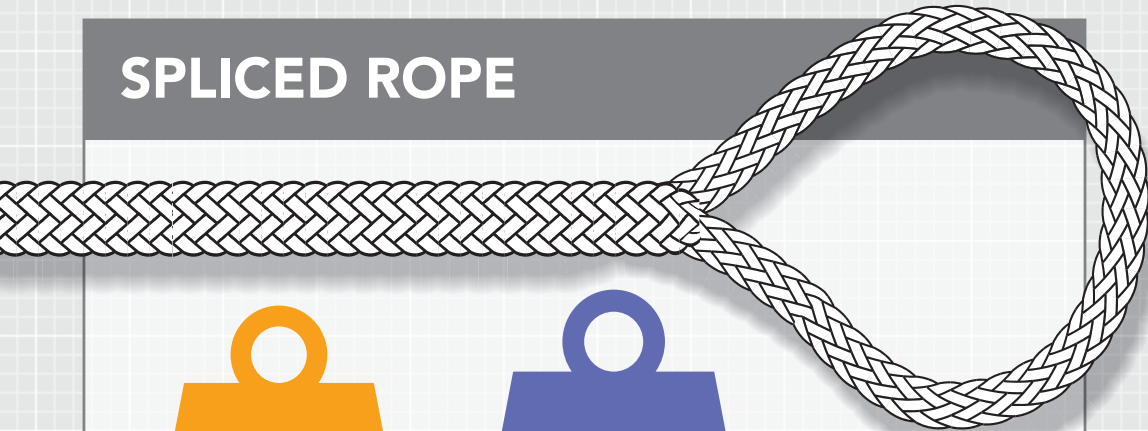

\* Quoted strength is for spliced rope

## KNOTTED ROPE

### Figure 8 Loop

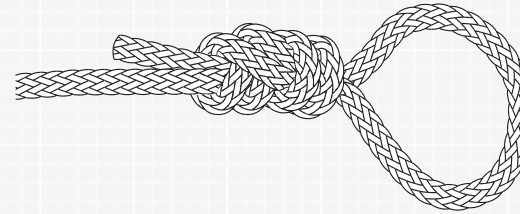

### Bowline

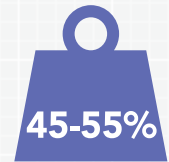
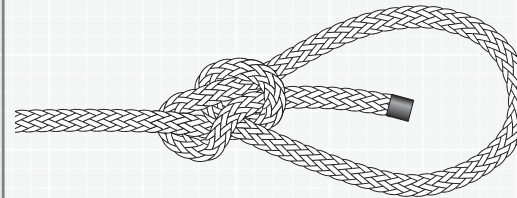

### Round turn 2 half hitches

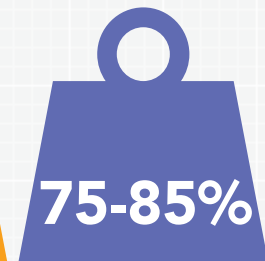
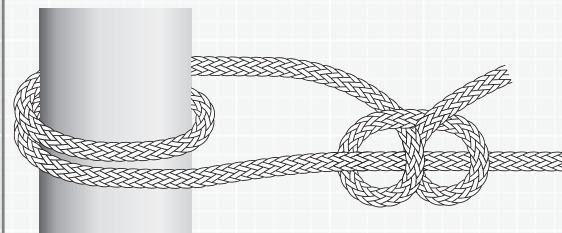

Doublebraid



Marlowbraid



D2



D12

**Marlow**<sup>®</sup>

www.marlowropes.com



DEALER STAMP



Marlow Ropes Ltd.  
Ropemaker Park  
Hailsham  
East Sussex, BN27 3GU  
United Kingdom  
+44 (0) 1323 444 444  
yachting@marlowropes.com



Marlow Ropes, Inc.  
10 Cordage Park Circle  
Suite 228  
Plymouth  
MA 02360  
United States  
+1 508 830 0444  
salesusa@marlowropes.com

**WWW.MARLOWROPES.COM**

**#RIGGEDBYMARLOW**



Certification No: 315  
ISO 9001:2015